



Thunderstone[®]
manufacturing LLC

QUALITY TARP SYSTEMS & TRAILER ACCESSORIES



TRAILER ACCESSORIES

2025 PARTS CATALOG

LOBBY COPY

Effective 01/01/2025

Rev 1

PROVIDING YOU

WITH QUALITY TARP SYSTEMS & TRAILER ACCESSORIES



Lincoln Manufacturing Center



Lincoln Manufacturing Center: Elevating Thunderstone Manufacturing to New Heights

Thunderstone is excited to introduce its brand-new Lincoln Manufacturing Center, a 200,000 square-foot facility located in the Industrial Air Park of Lincoln, Nebraska. This \$22 million investment is a cornerstone in Thunderstone’s strategy to enhance its production capabilities and lead the way in trailer innovation. Housing Thunderstone Manufacturing, Timpfe Equipment Trailers, and the Timpfe Parts Center, this cutting-edge facility is designed to revolutionize trailer manufacturing and meet the growing demands of our customers.

Setting a New Standard: Commitment to Excellence

As the new home of Thunderstone, the Lincoln Manufacturing Center isn’t just about scaling up production—it’s about redefining the standards of trailer quality. Thunderstone is deeply committed to creating the best products in the market, and this facility is central to achieving that goal. With an expanded production footprint and a host of new capabilities, we are ready to set the bar higher for the entire industry.

Our vertical integration strategy, paired with advanced systems, will ensure that every component meets the highest standards of quality, durability, and performance. The Lincoln Manufacturing Center will also play a pivotal role in expanding our product lineup, enabling Thunderstone to respond faster to market needs and introduce new, innovative product designs.

New Innovations: The Future of Trailer Manufacturing

At the heart of the Lincoln Manufacturing Center is an array of advanced manufacturing technologies that will set new industry benchmarks. This facility is designed to deliver higher-quality products through state-of-the-art equipment, ensuring precision and efficiency in every step of the production process.

Key features include:

- **Precision Cutting Technology:** Delivers ultra-precise cuts while minimizing material waste.
- **Machining Center:** Enhancing the speed and accuracy of metal machining operations.
- **Advanced Paint Line:** Ensuring flawless powder-coat finishes and improved durability for every component.
- **Vertical Integration:** Accelerating response times and boosting industry innovation by streamlining production. With enhanced control over every aspect of the manufacturing process, Thunderstone can quickly adapt, reduce delays, and improve overall efficiency.
- **Innovative Product Development Capabilities:** The new facility will serve as a hub for creating innovative new product designs, meeting the evolving needs of our customers.

These cutting-edge innovations will allow Thunderstone to drastically improve production capacity and lead the way in new product development, ensuring that we stay at the forefront of the manufacturing industry.

Parts Catalog 2024

Featured Products	6
Ordering/Contact Information	7
Thunder 7000 Power Tarp System	8-13
Rear Flex Arm	14-15
Power Cord Kits/Cable/Circuit Breakers	16
Front Bungee Kit	17
Crank Handles & Retainer Assembly	18
Universal Ridge Straps	19
Rear Roll Returns	20
Trap Vibrator Kit	21-22
EZ Flow Hydraulic Power Trap	23-30
Trailer Accessories	31
Tarp Accessories	32-33
Tubes & Latch Plates	34
Replacement Tarp Caps	35
Tarp Bows	36
Grain Cart Kits/Tarps	37-38
Replacement Tarps	39-55
One Piece Tarps	41-42
Standard Tarps	43-50
Standard Specialty Width Tarps	51
Reinforced Tarps	52
EPA	53
Mesh/End Dump Tarps	54
Specialty Tarps/Decontamination Tarps	53
Ridgepole Tarps	53
Tarp Repair Kit	55
Product Warranty	56
Roughneck EZ Flow Hydraulic Power Trap	58-60
Roughneck Thunder 7000 Power Tarp System	60-64
Roughneck Product Warranty	65



ONE-PIECE & STANDARD TARPS

Thunderstone Manufacturing is proud to announce that effective April 1, 2025, all One-piece tarps will transition to 123" wide instead of the current 117". Since introduced in 2022, the one-piece tarp offering has quickly become the industry standard with proven high-quality performance.

Effective April 1, 2025, all standard black vinyl 123" and 129" 18 oz.& 22oz. tarps will transition to one-piece construction. The only panel tarps will be colored, mesh, ridgepole, end dump, etc. and speciality tarps.

CUSTOM & SPECIALITY TARPS

Don't see a tarp size listed within our catalog? Thunderstone Manufacturing has the ability to create customized tarps to fit your customer needs. Our team is happy to give a quote based on tarp dimension, weight, color, and material needs within 24 hours. Turnaround time may vary based on final tarp configuration.

THUNDER 7000 POWER TARP SYSTEM COLORED SYSTEMS

Upgrade to a colored Thunder Power System kit now for the same price as mill finish! All full arm systems, and replacement parts, now cost the same as standard mill finish.

Colors Available for Thunder 7000 Power Tarp Arms



Black - 03



White - 04



Hammered Gray - 05

REDESIGNED TARP MOTOR

The Thunder Power Tarp System motor has been redesigned for improved functionality, ease of servicing, and change from oil to grease to prevent leaks.

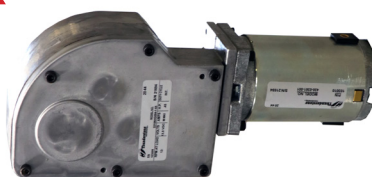

Email Ordering Format:

Part Number - Brief Description - Quantity

You will receive a confirmation back on receipt of order within 24 hours

Shipping charges will be added to orders based on volumes and destination.

Please feel free to communicate directly with Thunderstone on any issues you have with quality, delivery, cost, or after sales support. We will be carrying these parts in large quantities at our Lincoln, NE facility and your lead-times will be short, 1-5 working days for most parts. Our goal is to always have the part on the shelf for your service and over the counter part requirements.

Thunderstone Manufacturing is please to announce an online e-commerce store will be rolling out in Q1 2025. Following launch, pricing shown online will supercede printed catalog prices when applicable.

» Please send all orders to the following email address: sales@thunderstonemfg.com

GENERAL MANAGER



Andy Bednar
abednar@thunderstonemfg.com

DEALER SALES REP.



Justin Jones
jjones@thunderstonemfg.com

WARRANTY/TECHNICAL SUPPORT



Andrew Bohnenstingl - Primary
abohnenstingl@thunderstonemfg.com

TECHNICAL SUPPORT

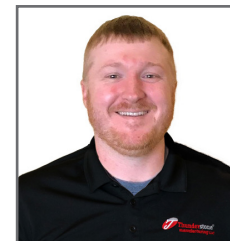

Martin Ourada
mourada@thunderstonemfg.com

OFFICE MANAGER



Michele Hagen - Primary
mhagen@thunderstonemfg.com

INSIDE SALES SUPPORT



Lila Uribe
luribe@thunderstonemfg.com

CONTACT INFORMATION

Thunderstone Manufacturing, LLC
4545 West Cuming Street
Lincoln, NE 68524
(P) 402.435.4249
(E) sales@thunderstonemfg.com

OVERSIZE FREIGHT NOTICE

Due to world wide freight challenges numerous freight carriers have implemented oversize freight fees that are of significance. These will impact our larger components in the catalog. They will be marked on each product affected by the following way: ***Overlength charges may apply see page 5 for details.**

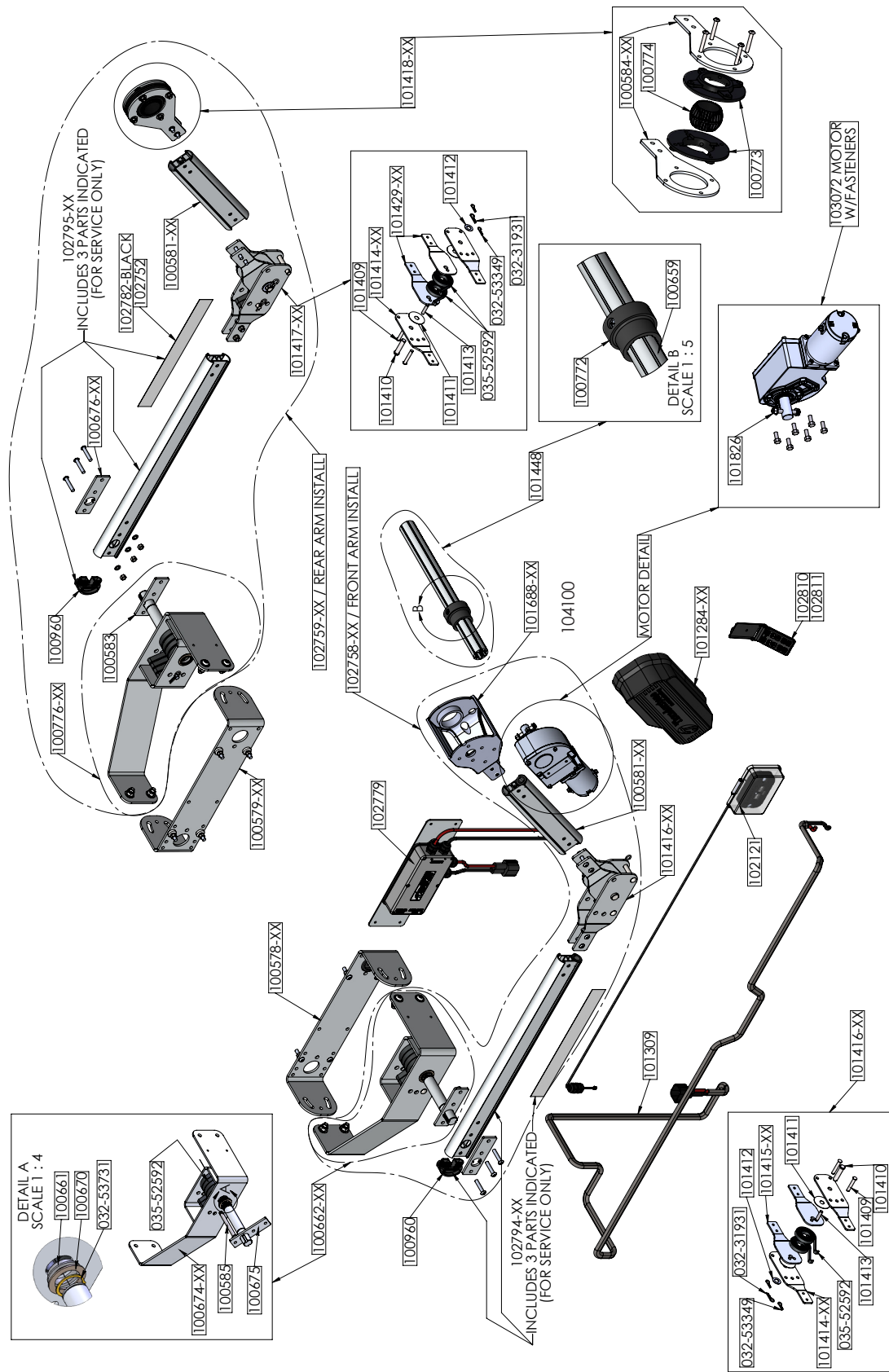

FITS ALL MAKES & MODELS OF GRAIN TRAILERS

NO UPCHARGE FOR COLORED ARMS!

Thunder Power Tarp 7000 Series - Standard Mill Finish

PART NO.	SIZE/DESCRIPTION	UNIT
102745-01	Thunder Power Tarp 7000 Series with One-Touch (Dual Arm) - Mill	EA
102746-01	Thunder Power Tarp 7000 Series with One-Touch (Single Arm) with HD Rear Roll Return - Mill	EA
104120-01	Thunder Power Tarp 7000 Series with One-Touch (Rear Rotary Flex Arm) - Mill	EA
102748-01	Thunder Power Tarp 7000 Series with One-Touch (Single Arm) with Reel Roll Return - Mill	EA

Power Cord Kit Sold Separately - See Page 16

Colors Available for Thunder 7000 Power Tarp Arms



Arm Replacement Assemblies

PART NO.	SIZE/DESCRIPTION	UNIT
102749-01	Front Arm Install w/ Electronics (Box 1)	EA
102749-Color Options	Front Arm Install w/ Electronics (Box 1) - Colored Options	EA
102750-01	Rear Arm Install w/ Inner Mounting Bracket (Box 2) - Mill	EA
102750-Color Options	Rear Arm Install w/ Inner Mounting Bracket (Box 2) - Colored Options	EA
102758-01	Front Arm Install / Includes Motor - Mill**	EA
102758-Color Options	Front Arm Install / Includes Motor - Colored Options**	EA

**Does Not Include Mounting Bracket

Assembly Outer Arm Mount

PART NO.	DESCRIPTION	UNIT
100662-01	Front Assembly	EA
100776-01	Rear Assembly	EA



Front Assembly

*Color Options Available
Black(-03)/White(-04)/Hammered Gray(-05)



Rear Assembly

*Color Options Available
Black(-03)/White(-04)/Hammered Gray(-05)

Arm Mounting Bracket - Only

PART NO.	UNIT
100674-01	EA



*Color Options Available
Black(-03)/White(-04)/Hammered Gray(-05)

Plug Arm End

PART NO.	UNIT
100960	EA



Upper Arm Extrusion 16" Long

PART NO.	UNIT
100581-01	EA



*Color Options Available
Black(-03)/White(-04)/Hammered Gray(-05)

Nuts & Bolts for Arm

PART NO.	UNIT
101825	EA



Mounting Bracket

PART NO.	DESCRIPTION	UNIT
100578-01	Front Mount	EA
100579-01	Rear Mount	EA



Front Mount

*Color Options Available
Black(-03)/White(-04)/Hammered Gray(-05)



Rear Mount

*Color Options Availab
Black(-03)/White(-04)/Hammered Gray(-05)

*Hardware Included

Cast Motor Head Assembly

PART NO.	UNIT
104100-01	EA



*Hardware Included

*Color Options Available
Black(-03)/White(-04)/Hammered Gray(-05)

Thunder 7000 Decal

PART NO.	DESCRIPTION	UNIT
102752	Standard	EA
102782	Black Arm Only	EA



Lower Arm Assembly (7000 Front & Rear)

PART NO.	DESCRIPTION	UNIT
102794-01	Front Arm Assembly	EA
102795-01	Rear Arm Assembly	EA



*All Color Options Available

Motor Cover

PART NO.	DESCRIPTION	UNIT
101826	Motor Shoulder Bolt	EA
101284-03	Black Motor Cover	EA
034-58345	Motor Wire Grommet	EA



Lower Arm Pivot Pin

PART NO.	DESCRIPTION	UNIT
100675	Front Pivot Pin	EA
100583	Rear Pivot Pin	EA



Front



Rear

Front Spring Knuckle Assembly

PART NO.	UNIT
101416-01	EA



*Color Options Availabl
Black(-03)/White(-04)/Hammered Gray(-05)

Rear Spring Knuckle Assembly

PART NO.	UNIT
101417-01	EA



*Color Options Available
Black(-03)/White(-04)/Hammered Gray(-05)

Outer Plate Lower Arm Pivot

PART NO.	UNIT
100676-01	EA



*Color Options Available
Black(-03)/White(-04)/Hammered Gray(-05)

Pin Clevis

PART NO.	LOCATION	SIZE	UNIT
100585	Lower Pivot Spring	1/2" x 4.5"	EA
101409	Center Pivot Adaptor	1/2" x 3"	EA
101410	Center Pivot	3/4" x 3"	EA
101413	Center Pivot Spring Holder	1/2" x 2"	EA



Tarp Motor Assembly

PART NO.	DESCRIPTION	UNIT
103072	Gear Box/Motor/Hardware	EA

Features New Leak Free Design!

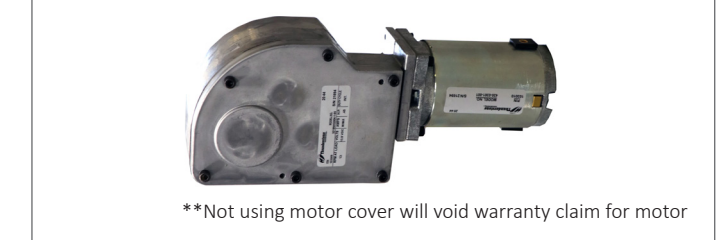

Aluminum Spacer & Retainer Ring

PART NO.	UNIT
100670	EA
032-53731	EA



100670



032-53731

Spring Spiral Torsion 1.25"

PART NO.	UNIT
035-52592	EA



Stabilizing Bushing

PART NO.	UNIT
100661	EA



Multi-Function Remotes

PART NO.	DESCRIPTION	UNIT
102810	Standard Remote	EA
102811	Lift Axle Remote	EA
035-52097	Replacement Battery	EA



Locking Collar 2" ID x 1" Long

PART NO.	UNIT
034-53699	EA



Spherical Bushing Mount Bracket

PART NO.	UNIT
100584-01	EA

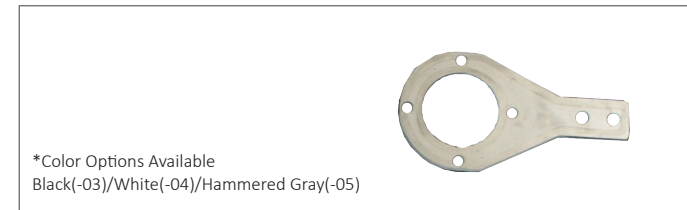

Rear Arm Bushing Assembly

PART NO.	UNIT
101418-01	EA



Plastic Spherical Bushing Housing & Ball

PART NO.	DESCRIPTION	UNIT
100773	Housing	EA
100774	Ball	EA



Keypad

PART NO.	DESCRIPTION	UNIT
102121	Keypad - Includes Cover Box	EA
577-301273	Keypad Cover Box Only	EA
034-53341	Rubber Keypad Grommet	EA
103262	Keypad Programming Tool	EA



Control Box - Thunderstone Motor Only

PART NO.	DESCRIPTION	UNIT
102779	Control Box	EA
104482	Control Box Screw	EA



Harness Wiring - Motor to Harness

PART NO.	DESCRIPTION	UNIT
101309	Motor to Harness	EA
101619	Relay to Harness	EA

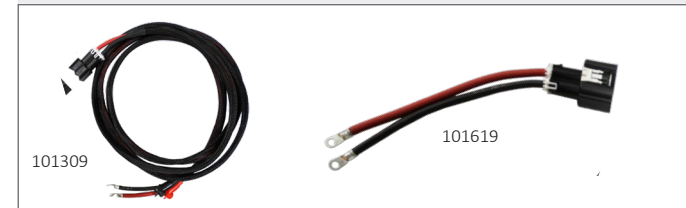

Motor Adaptor Assembly

PART NO.	DESCRIPTION	UNIT
101448	21" Tube	EA
101776	42" Tube (Rotary Flex Arm)	EA
104275	84" Tube (Rotary Flex Arm)	EA
100772	Plastic Bushing Motor End	EA



Thunder 7000 Upgrade Kit

PART NO.	DESCRIPTION	UNIT
103977	One-Touch Upgrade Kit	EA

AVAILABLE FOR:
3500 Series, GT Series,
5000 Series, 6000 Series

***Not recommended for any other type of electric tarp system**

FEATURES & BENEFITS

- One-Touch Technology enabled
- Increased motor speed
- Redesigned remote transmitter
- Easily start, stop, & reverse your tarp direction
- Constant tarp tension
- Proven performance of the Thunderstone Power Tarping System
- **1 year warranty**

Hardware & Fasteners

PART NO.	SIZE/DESCRIPTION	UNIT
034-53341	Grommet - 7/8" ID x 1-5/8" OD x 1-1/4" GD x 1/4" GW	EA
034-53342	Grommet - 7/8" ID x 1-1/4" OD x 1" GD x 1/4" GW	EA
034-53343	Grommet - 7/8" ID x 1-1/8" OD x 1" GD x 13/32" GW	EA
032-53344	Screw - 1/2" x 1-1/2" Button Head	EA
032-53691	Screw - 3/8" x 1-3/4" Button Head	EA
032-51883	Screw SS Self-Drilling - 1/4" x 1"	EA
032-10157	Screw Self-Tapping - 1/4" x 1"	EA
035-45879	Roll Pin 3/8" OD x 2" Long Hinge Pin	EA
032-53908	Nut 1/2" - 13 Nylock Top - Lock	EA
101007	Screw Self-Drilling - #14 - 14 x 3/4"	EA
032-01326	Ribbed Carriage Bolt - 3/8" x 1-1/4"	EA
100661	Front/Rear Arm Pivot Bushing	EA
032-53349	Pin Cotter Hair Pin 1/8" Wire	EA
100732	Replacement Control Box Hardware	EA
032-01356	3/8" x 1" Self Tapping Screw	EA
032-53731	Retainer Ring	EA
032-24323	Nylon Spacer	EA
100778	Cotter Pin	PKG 50

Flex Arm Adjustable Lower Arm

PART NO.	UNIT
101114-01	EA



Flex Arm Head Adaptor

PART NO.	UNIT
101109-01	EA

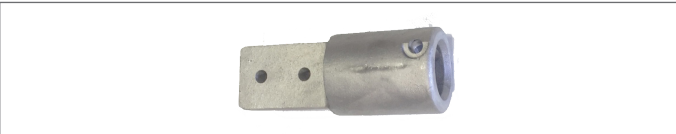

Pivot Rotary Flex Arm Assembly

PART NO.	UNIT
104118	EA



Inner Bracket

PART NO.	DESCRIPTION	UNIT
104295-01	Inner Bracket	EA



**Hardware Included

Hardware & Fasteners

PART NO.	SIZE/DESCRIPTION	UNIT
100765	Bolt 3/8" x 2" Button Head	EA
100769	Screw 5/16" - 18 x 1-1/4"	EA
032-44905	Wash 3/8" Flat SS	EA
032-58346	Bolt 3/8" - 16 x 2-1/2" GR8 Hex	EA
032-01405	Nut 3/8" - 16 P-Lock Hex HD	EA
100775	Bolt 5/16" x 2" Button HD	EA

Cable Flex Arm 60"

PART NO.	UNIT
101111	EA



Tapered Roller Bearing

PART NO.	UNIT
104114	EA

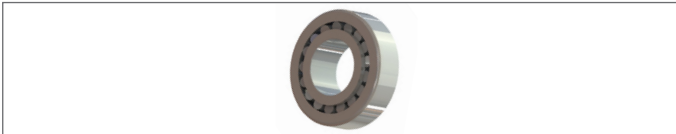

Snap Ring

PART NO.	UNIT
104115	EA



Flex Arm Coupling with Spline

PART NO.	UNIT
104116	EA



Rubber Boot & Clamp

PART NO.	DESCRIPTION	UNIT
152912	Rubber Boot	EA
035-53428	Clamp	EA



Outer Arm Bracket

PART NO.	UNIT
100776	EA



Flex Arm Replacement

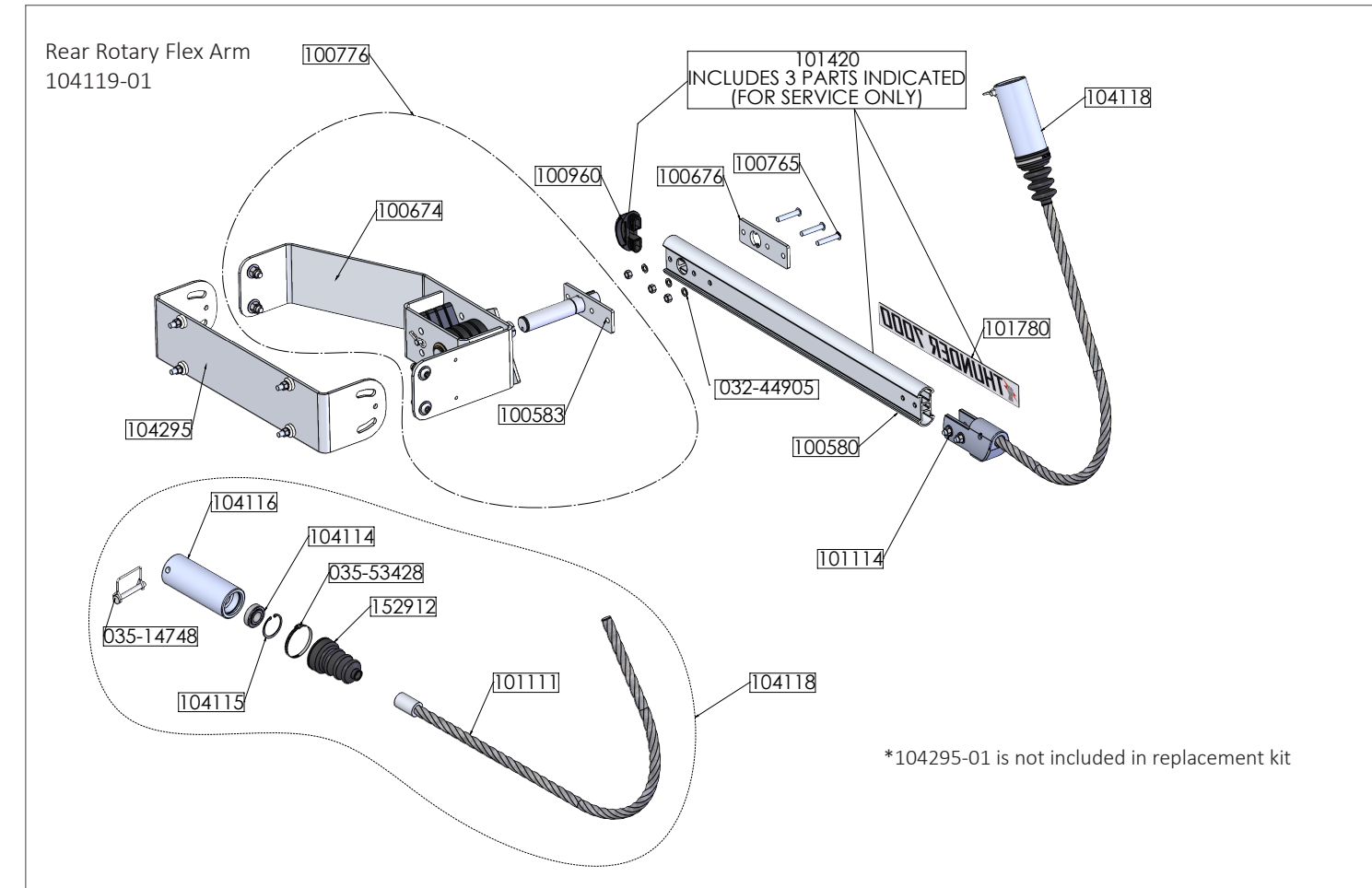

PART NO.	UNIT
104119-01	EA
104119-Color Options	EA

Power Cord Kits/Cable

PART NO.	GA	LENGTH	AMP	DESCRIPTION	RECOMMENDED USE	UNIT
577-53363	6	25'	50	25' Power Cord Kit / 2 Pole Plug/ With Lugs	Thunder 7000 Power Tarp/ 6000 ^{XR} / 5000 Series	EA
577-61116	4	25'	100	25' Power Cord Kit / 2 Pole Plug/ With Lugs	Standard EZ Flow Hydraulic Trap	EA
577-54366	4	25'	No Breaker	25' Power Cord Kit / 2 Pole Plug / With Lugs	Standard EZ Flow Hydraulic Trap	EA
577-58996	4	20'	No Breaker	20' Power Cord Kit / 2 Pole Plug / With Lugs	EZ Flow Hydraulic Trap 54" Door	EA



Circuit Breakers

PART NO.	DESCRIPTION	UNIT
101521	50 Amp Automatic Reset	EA
031-51335	100 Amp Automatic Reset	EA
031-58995	150 Amp Automatic Reset	EA

50 Amp:
Thunder Power Tarp 6000^{XR}
Thunder Power Tarp 5000 Series
Thunder Power Trap Work Lights

100 Amp:
EZ Flow Hydraulic Trap

150 Amp:
EZ Flow Hydraulic Trap 54" Door

Coiled Wire Assembly w/ Dual Plug 6GA 15'-9"

PART NO.	DESCRIPTION	UNIT
035-50248	Vertical	EA



Cable Dual Conductors

PART NO.	GA	LENGTH	DESCRIPTION	UNIT
031-51092	4	Bulk Min. Order 20'	Cable Dual Conductor	FT.
031-49371	6	Bulk Min. Order 20'	Cable Dual Conductor	FT.
104536	6	500' Spool	Cable Dual Conductor	EA



Wire Lugs

PART NO.	DESCRIPTION	UNIT
031-51117	6 GA Straight 3/8"	EA
031-51067	6 GA Straight 1/4"	EA
031-51066	4 GA Straight 1/4"	EA
031-51093	4 GA Straight 3/8"	EA



Wire Assembly Jumper 4GA Red 4"

PART NO.	UNIT
031-52365	EA



Plug - 2 Pole

PART NO.	DESCRIPTION	UNIT
031-51222	Vertical Pin	EA



Boot Rubber - 2 Pole Vertical 6GA

PART NO.	UNIT
034-51020	EA



Receptacle - 2 Pole Vertical 6GA

PART NO.	DESCRIPTION	UNIT
031-51223	Vertical	EA



Front Bungee Kit

PART NO.	DESCRIPTION	UNIT
596-43051	Front Bungee Kit - 1 Piece	EA
101190	Front Bungee Kit - 2 Piece	EA

**Overlength charges may apply see page 5 for details. Part #596-43051 ONLY*



*All Hardware Included

PVC Pipe - 10'

PART NO.	UNIT
034-43053	EA



Roll Return End Plug

PART NO.	UNIT
035-43049	EA



Rope - Stretch 11'5"

PART NO.	DESCRIPTION	UNIT
035-14753	3/8"	EA



Flexible Protective Cover

PART NO.	UNIT
034-43050	EA



Rope - Stretch

PART NO.	UNIT
033-43054	FT.



Spools of 500 ft. Available

Eye Bolt Assembly

PART NO.	UNIT
577-53726	EA



Flex Crank Arm Kit

PART NO.	DESCRIPTION	UNIT
035-56193	Flex Crank Arm Assembly - 54" Extension (80" Long)	EA
035-33651	Flex Crank Arm Assembly - 96" Extension (122" Long)	EA

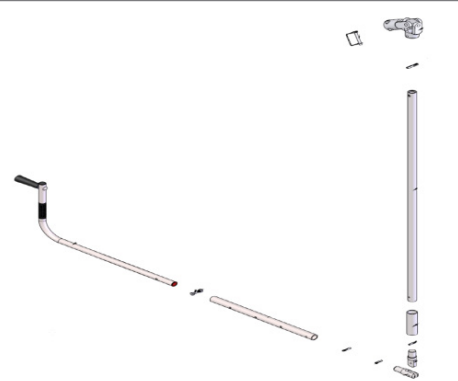

Crank Retainer Bracket

PART NO.	DESCRIPTION	UNIT
051-42976	Retainer Crank Handle - Bracket Only	EA



Crank Handle Storage Kit

PART NO.	UNIT
100037	EA



Crank Extension

PART NO.	DESCRIPTION	UNIT
577-43069-01280	80"	EA
577-43069-01536	96"	EA



**Overlength charges may apply see page 5 for details. Part #577-43069-01536 ONLY*

Spline U-Joint Hinge Pin

PART NO.	UNIT
035-45879	EA

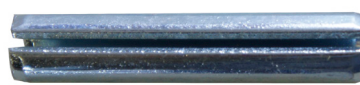

Lower Crank Handle Assembly

PART NO.	DESCRIPTION	UNIT
577-51870	Lower Crank Handle Assembly	EA
577-53730	Replacement Handle	EA



Removeable Crank Retainer Kit

PART NO.	UNIT
103568	EA



Pin - Loxall - 3/8" Diameter

PART NO.	UNIT
035-14748	EA



Splined U-Joint

PART NO.	UNIT
035-31595	EA



Universal Ridge Strap Kit - 56'

PART NO.	DESCRIPTION	UNIT
100097	Universal Ridge Strap Kit - 56'	EA



Ridge Strap Ratchet

PART NO.	UNIT
035-41887	EA



56' Ridge Strap

PART NO.	UNIT
035-45887-10752	EA



Bushing - Ridge Strap

PART NO.	UNIT
035-43070	EA



Ridge Strap Kit with Hook (Wilson Style)

PART NO.	DESCRIPTION	UNIT
100920	Ridge Strap Kit with Hook (Wilson Style)	EA



Ridge Strap Ratchet with Hook 18"

PART NO.	UNIT
100922	EA



Ridge Strap with Hook 56'

PART NO.	UNIT
100921	EA



Rear Roll Returns

PART NO.	DESCRIPTION	UNIT
101334	Standard Rear Roll Return	EA
101335	Heavy Duty Rear Roll Return	EA
101886	Front Roll Return	EA



Also Available in Boxes of 5

Roller Bearing

PART NO.	UNIT
035-39445	EA



Heavy Duty Roll Return Reel

PART NO.	SIZE	UNIT
101965	2"	EA
101966	3"	EA



Return Cord Standoff

PART NO.	UNIT
101967	EA



Roll Return Cable Guide

PART NO.	UNIT
596-43585	EA



Roll Return Cable

PART NO.	UNIT
035-40612	EA



Roll Return Reel Strap

PART NO.	SIZE	UNIT
101857	2"	EA
101968	3"	EA



Roll Return Reel Collar

PART NO.	SIZE	UNIT
101819	2"	EA
101820	3"	EA



Universal Vibrator Trap Frame Kit

PART NO.	UNIT
100625	EA



Knock Rail Vibrator Kit

PART NO.	UNIT
100870	EA



Vibrator Impacting Hammer 2"

PART NO.	DESCRIPTION	UNIT
021-300006	2" Impact	EA
102831	3/8" Port Protector	EA
102833	3/8" Gasket Cap	EA
040-62040	Shim	EA



Vibrator Impacting Hammer 1-1/8"

PART NO.	DESCRIPTION	UNIT
021-60685	1-1/8" Impact	EA
102830	1/4" Port Protector	EA
102832	1/4" Gasket Cap	EA



Trap Frame Vibrator Bracket

PART NO.	DESCRIPTION	UNIT
577-45926	2" Impact	EA
101518	1.25" Impact	EA

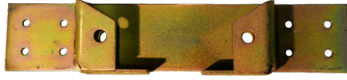

Quick Connector & Ball Valve

PART NO.	UNIT
577-57080	EA



Coiled Air Line with 1/4" Fittings

PART NO.	DESCRIPTION	UNIT
021-34909	Coiled Airline	EA
021-46083	Fitting Coupler	EA



FLR Gauge

PART NO.	UNIT
102801	EA



For 102798 only

FLR Oiler Regulator with Bracket

PART NO.	DESCRIPTION	UNIT
102803	1/4" Port	EA
104068	1/2" Port	EA



2019 Or Older FLR Replacement Parts

PART NO.	DESCRIPTION	UNIT
021-45954	RexRoth FLR	EA
035-54560	Button Muffler	EA



Knock Rail Vibrator Bracket

PART NO.	DESCRIPTION	UNIT
577-34904	2" Impact	EA



Pressure Protection Valve

PART NO.	UNIT
101117	EA



Ball Valve with Handle

PART NO.	DESCRIPTION	UNIT
021-46460	3/8" Port	EA
021-60248	1/2" Port	EA



FLR Kit with Brackets

PART NO.	DESCRIPTION	UNIT
102798	FLR Kit w/ Brackets (1/4" port)	EA
021-60249	FLR Kit w/ Brackets (1/2" port)	EA
103193	FLR O-Ring Reservoir	EA



FLR Mounting Brackets - Replacements

PART NO.	DESCRIPTION	UNIT
102799	Mounting Bracket	EA
102800	Connecting Bracket	EA
104111	FLR O-Ring Body	EA

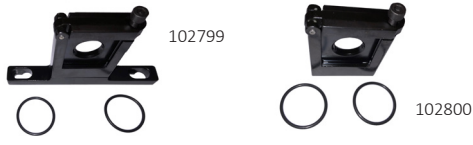

1/2" Port Adapter

PART NO.	UNIT
102802	EA



The patented EZ Flow Hydraulic Trap™ System has been thoroughly tested to meet your tough hauling demands. From field to road there is no hydraulic or electric trap that compares to strength and reliability of the EZ Flow.

**Lead times may vary for EZ Flow Kits*

Features

- The operator can stay out of the dust by opening the traps from the cab of the truck, using the multi-function remote.
- Operates using a single 12 volt hydraulic motor
- Hydraulic hoses and stainless steel fittings for increased durability
- No trap operator or motor to interfere with swing auger
- Easily control product flow by feathering the door open and close
- Heavy duty reinforcement brackets for hi-density commodities (Frac Sand)
- Hydraulic motor and reservoir are protected in the apex of the trailer
- Quick release pins
- Simple 3 button remote design with large easy-to-read buttons
- Multi-function remote programs up to 5 trailer accessories
- Easy to install



Standard Remote



EZ Flow Hydraulic Trap

Reflects 2 Door Trailers

PART NO.	WIDTH	MAKE	DESCRIPTION	CYLINDER SIZE
101654	96"	Timpte	Fits 33'-5" 2012 & Newer Timpte Ag Hopper	32"
101509	102"	Timpte	Fits 33'-5" 2012 & Newer Timpte Ag Hopper	32"
101655	96"	Timpte	Fits 33'-5" 2011 & Older Timpte Ag Hopper	27"
101656	102"	Timpte	Fits 33'-5" 2011 & Older Timpte Ag Hopper	27"
100099	96"	Timpte	Fits 38'/40'/42'2" 2011 & Older Timpte Ag Hopper with Roller Doors	31"
101025	102"	Timpte	Fits 38'/40'/42'2" 2011 & Older Timpte Ag Hopper with Roller Doors	31"
100511	96"	Timpte	Fits 43'/48'/50' 2011 & Older Timpte Ag Hopper with Roller Doors	40"
100515	102"	Timpte	Fits 43'/48'/50' 2011 & Older Timpte Ag Hopper with Roller Doors	40"
100513	96"	Timpte	Fits 38'/40'/42'2" 2011 & Older Timpte Std/Split Hopper with Roller Doors	40"
101026	102"	Timpte	Fits 38'/40'/42'2" 2011 & Older Timpte Std/Split Hopper with Roller Doors	40"
101390	96"	Timpte	Fits 38'/40'/42'2" 2012 & Newer Timpte Ag Hopper	36"
101391	102"	Timpte	Fits 38'/40'/42'2" 2012 & Newer Timpte Ag Hopper	36"
101392	96"	Timpte	Fits 38'/40'/42'2" 2012 & Newer Timpte Std/Split Hopper - Stillwell Cylinders	46"
101393	102"	Timpte	Fits 38'/40'/42'2" 2012 & Newer Timpte Std/Split Hopper - Stillwell Cylinders	46"
101394	96"	Timpte	Fits 43'/48'/50' 2012 & Newer Timpte Ag Hopper - Stillwell Cylinders	46"
101395	102"	Timpte	Fits 43'/48'/50' 2012 & Newer Timpte Ag Hopper - Stillwell Cylinders	46"
101533	96"	Timpte	Fits 43'/48'/50' 2011 & Older Timpte Std/Split Hopper with 36" Doors	40"
101534	102"	Timpte	Fits 43'/48'/50' 2011 & Older Timpte Std/Split Hopper with 36" Doors	40"
101535	96"	Timpte	Fits 43'/48'/50' 2012 & Newer Timpte Std/Split Hopper with 36" Doors	46"
101536	102"	Timpte	Fits 43'/48'/50' 2012 & Newer Timpte Std/Split Hopper with 36" Doors	46"
101587	96"	Timpte	Fits 43'/48'/50' 2002 & Newer Timpte Std/Split Hopper with 54" Doors	59"
101588	102"	Timpte	Fits 43'/48'/50' 2002 & Newer Timpte Std/Split Hopper with 54" Doors	59"
101186	96"	Timpte	21' x 96" W Ag Hopper Pup	-
100627	-	Wilson	Fits Wilson Strap Trap with 27" W x 31" L Doors	31"
100980	-	Wilson	Fits Wilson Strap Trap with 27" W x 43" L Doors	43"
101104	-	Wilson	Fits Wilson Strap Trap with 33" W x 31" L Doors	31"
100981	-	Wilson	Fits Wilson Strap Trap with 33" W x 43" L Doors	43"
101959	-	Cornhusker	Fits 24" W x 40" L Door - 0"-20" Apex Ag Tub	43"
101887	-	Cornhusker	Fits 24" W x 40" L Door - 20"-40" Apex Ag Tub	43"
101960	-	Cornhusker	Fits 24" W x 40" L Door - 40"-60" Apex Ag Tub	43"
102062	-	Cornhusker	Fits 24" W x 40" L Door - 60"-80" Apex Ag Tub	43"
101957	-	Cornhusker	Fits 30" W x 40" L Door - 0"-20" Apex Ag Tub	43"
101759	-	Cornhusker	Fits 30" W x 40" L Door - 20"-40" Apex Ag Tub	43"
101958	-	Cornhusker	Fits 30" W x 40" L Door - 40"-60" Apex Ag Tub	43"
102063	-	Cornhusker	Fits 30" W x 40" L Door - 60"-80" Apex Ag Tub	43"
102012	-	Cornhusker	Fits 30" W x 52" L Door - 0"-20" Apex Ag Tub	54"
102013	-	Cornhusker	Fits 30" W x 52" L Door - 20"-40" Apex Ag Tub	54"
102014	-	Cornhusker	Fits 30" W x 52" L Door - 40"-60" Apex Ag Tub	54"
102064	-	Cornhusker	Fits 30" W x 52" L Door - 60"-80" Apex Ag Tub	54"

**LEAD TIMES MAY VARY FOR EZ FLOW KITS
CALL FOR DIFFERENT SIZE CONFIGURATIONS**



OVERRIDE SYSTEM

In the event of an emergency due to electrical or mechanical issues the EZ Flow doors can be easily converted into manual operation. The emergency manual override utilizes quick release pins and straps to open the door. This new override system is not only easy to use, but provides additional ground clearance compared to previous override systems.

- Emergency Manual Override Includes**
- (2) Pre-Slotted Cross-Shaft
 - (2) Straps with Hooks
 - (1) Strap Enclosure with Bracket
 - (4) Cross-Shaft Mounts
 - (4) Composite Bushing with SS Housing Mounting Hardware

***KIT DOES BOTH DOORS**



PART NO.	DESCRIPTION	MODEL	TRAILER WIDTH
102294	EZ Flow Override Kit	Ag Tub	96"
102295	EZ Flow Override Kit	Ag Tub	102"
102296	EZ Flow Override Kit	Split Tub	96"
102297	EZ Flow Override Kit	Split Tub	102"
102301	EZ Flow Override Kit	Single Split Tub	102"
102302	EZ Flow Override Kit	High Ground Clearance Tub	102"

EZ Flow Keypad & Control Box

PART NO.	DESCRIPTION	UNIT
102232	EZ Flow Keypad - Standard	EA
102233	EZ Flow Control Box	EA
102231	EZ Flow Control Box & Keypad	EA



EZ Flow Tri-Hopper

PART NO.	DESCRIPTION	UNIT
152638	Upgrade Kit	EA
104552	EZ Flow Third Hopper Control Box	EA



Hydraulic Power Units

PART NO.	DESCRIPTION	UNIT
102214	Pump 12VDC Hyd. 1 Gallon Res	EA
034-56070	EZ Flow Pump Breather Vent	EA



Valves

PART NO.	DESCRIPTION	UNIT
103373	100 PSI Pilot Check Valve	EA



Multi-Function Remotes

PART NO.	DESCRIPTION	UNIT
102810	Standard Remote	EA
102811	Lift Axle Remote	EA
035-52097	Replacement Battery	EA



EZ Flow Keypad & Control Box - 54" Door

PART NO.	DESCRIPTION	UNIT
102232	EZ Flow Keypad - Standard	EA
102146	EZ Flow Control Box - 54" Door	EA
102285	EZ Flow Control Box & Keypad - 54" Door	EA



Hydraulic Power Units - 54" Door

PART NO.	DESCRIPTION	UNIT
035-59157	12VDC Hyd. 1.75gal Res (54" Door) - Pre 2019	EA
035-60668	12VDC Hyd. 1.75gal Res (54" Door) w/o solenid	EA
034-56070	EZ Flow Pump Breather Vent	EA

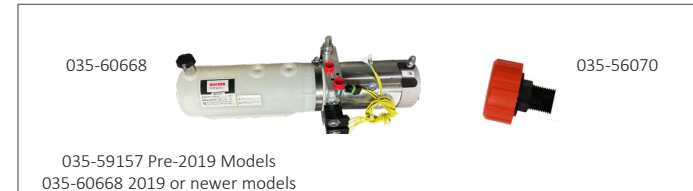

Switching Valve & Switching Coil - 54" Door

PART NO.	DESCRIPTION	UNIT
102560	Switching Valve	EA
102512	Switching Coil	EA



EZ Flow Keypad Bracket

PART NO.	MAKE	UNIT
103882	Timpte	EA
103883	Wilson / Cornhusker	EA



EZ Flow Hydraulic Fluid

Only Hydraulic oil recommended for EZ Flow

PART NO.	UNIT
577-55236	2 Gallon
101153	1 Gallon



Preventative Maintenance Kit

PART NO.	UNIT
101316	EA



Cap/Rubber Cylinder Rod End

PART NO.	DESCRIPTION	UNIT
034-58980	Cap/Rubber 3/4"	EA
034-55916	Cap/Rubber 5/8"	EA



Solenoid 12VDC 150 Amp

PART NO.	UNIT
031-58998	EA



Cross Shafts

PART NO.	DESCRIPTION	UNIT
365-58981	Shaft Cross for 96"w	EA
365-58982	Shaft Cross for 102"w	EA



Door Bracket - Quick Release

PART NO.	DESCRIPTION	UNIT
577-59749	CBSD Front/RDSD Rear	EA
577-59750	RDSD Front/CBSD Rear	EA



Quick Release Conversion Kit

PART NO.	ROD DIA	TRAILER WIDTH	UNIT
102000	5/8"	96"/102"	EA
102001	3/4"	96"	EA
102002	3/4"	102"	EA



Quick Release Yoke

PART NO.	SIZE	UNIT
035-59743	5/8 - 11 (Std Door)	EA
035-59744	3/4 - 10 (54" Door)	EA



Quick Release Pin

PART NO.	UNIT
035-59745	EA

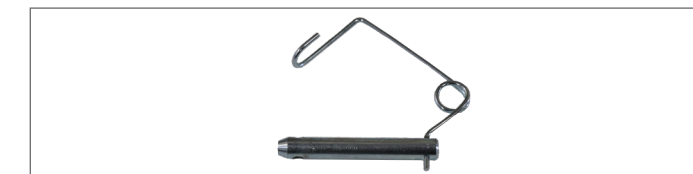

Blocking Valves

PART NO.	DESCRIPTION	UNIT
029-49864	Double Blocking Valve	EA
035-61109	Rubber Boot	EA



Override System Replacement Strap

PART NO.	UNIT
035-60814-00576	EA



Override System Box Unit

PART NO.	UNIT
034-61002	EA



Aftermarket Override Components

For use with existing cross shaft & gear rack

PART NO.	UNIT
101120	EA



EZ Flow Service Boot Kit

54" Door Installation Only

PART NO.	UNIT
577-60078	EA



Door Reinforcing Strap

PART NO.	UNIT
051-58968	EA



Override Nut with Groove Pin

PART NO.	UNIT
102074	EA



Door Bracket

PART NO.	DESCRIPTION	MAKE	UNIT
051-51919	RDS Front/CBSD Rear	Timpte	EA
051-51920	CBSD Front/RDS Rear	Timpte	EA
100629	RDS Front/CBSD Rear	Wilson	EA
100628	CBSD Front/RDS Rear	Wilson	EA



Door Bracket 54" Door

PART NO.	DESCRIPTION	UNIT
577-58969	26" w Door - 96" w	EA
577-58970	32" w Door - 102" w	EA
577-59751	26" w Door - 96" w (Quick Release)	EA
577-59752	32" w Door - 102" w (Quick Release)	EA



Junction Box Assembly

With 50 Amp Breaker for Existing Trap System

PART NO.	UNIT
101738	EA

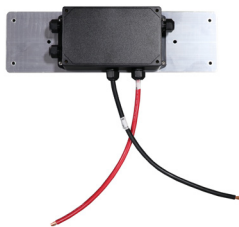

Hydraulic Cylinders

PART NO.	SIZE/DESCRIPTION	UNIT
029-64188	46" - '24 Timpte - Stillwell	EA
029-57700	32" - Timpte	EA
029-57701	36" - '17 Timpte	EA
029-57458	46" - '17 Timpte - Midwest	EA
029-51467	40" - Timpte	EA
029-50508	39" - Timpte	EA
029-50514	31" - Timpte	EA
029-52585	27" - Timpte	EA
029-59513	51" - Timpte	EA
100542	31" CBSD FRT/RDS RR - Wilson	EA
100543	31" RDS FRT/CBSD RR - Wilson	EA
100926	43" CBSD - Wilson	EA
100932	43" RDS - Wilson	EA
029-58381	59" - Timpte 54" Door	EA
101721	43" CBSD - Cornhusker	EA
101722	43" RDS - Cornhusker	EA
101973	54" CBSD - Cornhusker	EA
101974	54" RDS - Cornhusker	EA
032-51128	Jam Nut - 2 Cylinder	EA

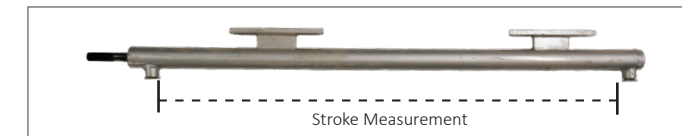

Hydraulic Adaptors

PART NO.	SIZE/DESCRIPTION	UNIT
029-49468	3/8" Straight 3/8" JIC-O-Ring	EA
029-49657	3/8" Elbow 90° 3/8" JIC-O-Ring	EA
029-51138	3/8" Elbow 90° 1/4" JIC-O-Ring	EA
029-50220	3/8" Elbow 3/8" O-Ring FJIC	EA
029-50222	3/8" Union Straight 3/8" JIC-JIC	EA
029-50223	3/8" Tee 3/8" JIC-FJIC	EA
029-50224	3/8" Elbow 3/8" JIC-JIC	EA
029-50225	3/8" Straight 3/8" JIC-O-Ring	EA
029-50435	3/8" Adaptor 90° 3/8" JIC-FJIC	EA

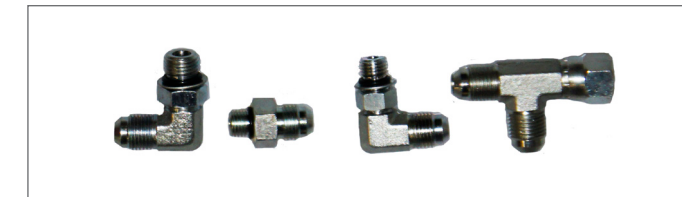

Hydraulic Power Unit Mounting Bracket

PART NO.	DESCRIPTION	UNIT
100970	Bracket - 1 Gal Res	EA
101590	54" Door Bracket	EA
103604	U-Bolt	EA

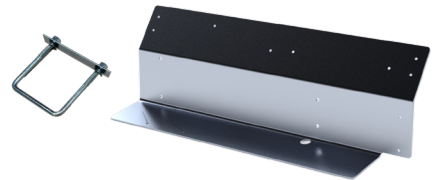

Wiring Harness / Wire

PART NO.	SIZE/DESCRIPTION	UNIT
031-50504	28' Red 4 GA w/ 1/4" - 3/8" Lugs	EA
031-51038-00288	18" Black 4 GA w/ 3/8" Lugs	EA
031-51269	Wire Assembly 18-1/2" Long 6 GA Black	EA
101187	EZ Flow Wiring Kit for Lead Pup Trailer	EA
031-58992	Cable Ay 4 GA Red 32' w/ 1/4" Lug	EA

Hydraulic Hoses

PART NO.	SIZE/DESCRIPTION	UNIT
029-51239	3/8"x104" Long - 3/8" FJIC x 3/8" 45° FJIC	EA
029-51240	3/8"x134" Long - 3/8" FJIC x 3/8" 45° FJIC	EA
029-51241	3/8"x152" Long - 3/8" FJIC x 3/8" 90° FJIC	EA
029-53989	3/8"x46-1/2" Long - 3/8" FJIC x 3/8" FJIC	EA
029-49648	3/8"x18-1/2" Long - 3/8" FJIC x 3/8" FJIC	EA
029-51087	3/8"x132" Long - 3/8" FJIC x 3/8" 90° FJIC	EA
029-53991	3/8"x56-1/2" Long - 3/8" FJIC x 3/8" FJIC	EA
029-51257	3/8"x164" Long - 3/8" FJIC x 3/8" 90° FJIC	EA
029-51081	3/8"x70" Long - 3/8" FJIC x 3/8" 45° FJIC	EA
029-51086	3/8"x80" Long - 3/8" FJIC x 3/8" 45° FJIC	EA
029-51458	3/8"x156" Long - 3/8" FJIC x 3/8" 45° FJIC	EA
029-51256	3/8"x122" Long - 3/8" FJIC x 3/8" 45° FJIC	EA
029-51459	3/8"x197" Long - 3/8" FJIC x 3/8" 90° FJIC	EA
029-51242	3/8"x176" Long - 3/8" FJIC x 3/8" 90° FJIC	EA
029-60122	3/8"x220" Long - 3/8" FJIC x 3/8" 90° FJIC	EA
029-53992	3/8"x52-1/2" Long - 3/8" FJIC x 3/8" FJIC	EA
029-56771	3/8"x62-1/2" Long - 3/8" FJIC x 3/8" FJIC	EA



Cylinder Rebuild Kit

PART NO.	DESCRIPTION	UNIT
102463	5/8" w/ Grease - Midwest - Pre 2024	EA
104406	5/8" w/ Grease - Stillwell	EA



Cylinder Rebuild Kit - 54" & 59" Doors

PART NO.	DESCRIPTION	UNIT
102464	3/4"	EA



EZ Flow Indicator Kit

PART NO.	UNIT
100741	EA

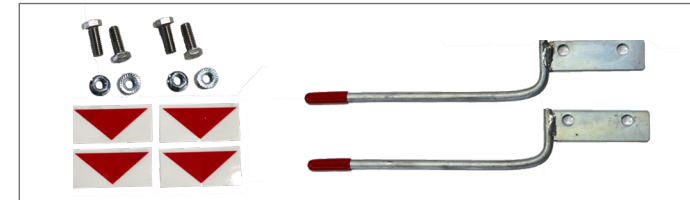

Timpte Sight Glass Window

PART NO.	DESCRIPTION	UNIT
577-59164	Timpte Vertical 4" x 8" Sight Glass Window - Pre-2022 Models	EA
103736	Timpte Horizontal Sight Glass Window - 2022 Models or Newer	EA
034-59168	Timpte Sight Glass Replacement	EA
034-59179	Timpte Sight Glass Gasket Replacement	EA

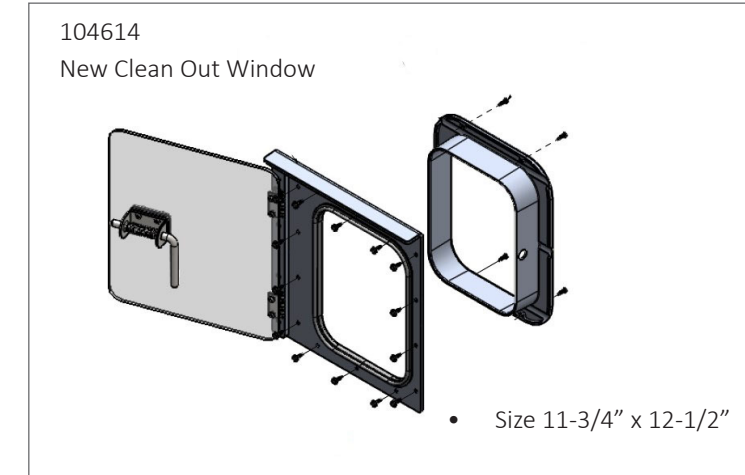

Clean Out Window

PART NO.	UNIT
104614	EA



Permit Holder

PART NO.	DESCRIPTION	UNIT
035-36799	Round Permit Holder	EA
035-28920	Cylinder Permit Holder	EA



Trickle Charging System

PART NO.	UNIT
035-63797	EA

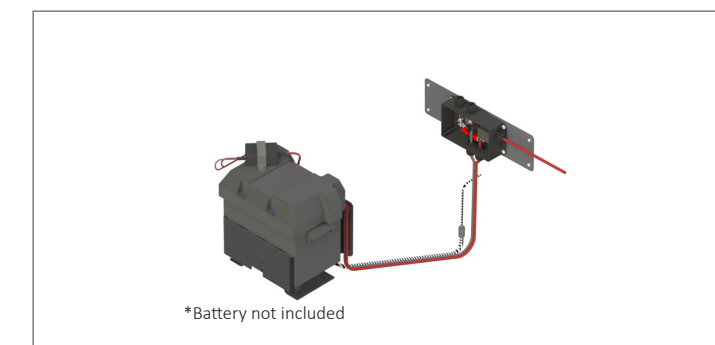



Wall Protectors & Screw

PART NO.	DESCRIPTION	UNIT
101056	Standard	3 Pack



**Hardware Included

Thunder Tarp Strap

PART NO.	DESCRIPTION	UNIT
035-52851	Thunder Tarp Strap	EA
104589	Thunder Tarp Strap (4' Longer) Grain Carts	EA



Upright Tarp Stop

PART NO.	UNIT
035-39428	EA



**60 per box

Tarp Stop Assembly

PART NO.	UNIT
035-25064	EA



*Self Tapping 3/8" x 1" (032-01356)

Flexible Tarp Stop

PART NO.	UNIT
035-42243	EA



Pin Retainer - 1/4" x 3" with Clip

PART NO.	UNIT
035-40800	EA



6" Offset Tarp Stop

PART NO.	UNIT
035-54090	EA



Tarp Stop (Bracket Only)

PART NO.	UNIT
051-39427	EA



U-Clamp - Nylon

PART NO.	UNIT
034-43057	EA



*Minimum order quantity- 25

Screw Self-Drilling #14 - 14 x 3/4"

PART NO.	UNIT
101007	EA



*Minimum order quantity- 25

U-Clamp & Screw Kit

PART NO.	UNIT
102075	EA



Kit Includes:
20 U-Clamps
20 Screws Self-Drilling

Roll Tubes - 50 Bundle

PART NO.	DIA	FT	IN	DESCRIPTION	UNIT
035-54216	2"	3	-	36" Double Swedged	EA
035-43064-04496	2"	23	5	281" Long Roll Tube	EA
035-43064-02240	2"	11	8	140" Long Grain Cart Roll Tube	EA



Roll Tube with Welded Spline Shaft

PART NO.	FT	IN	UNIT
577-53693	23	5	EA
100733	1	-	EA



Fixed Tubes - 127 Bundle

PART NO.	DIA	FT	IN	DESCRIPTION	UNIT
035-54215	1-1/8"	3	-	36" Double Swedged	EA
035-43063-04224	1-1/8"	22	-	264" Long Fixed Tube	EA
035-43063-02240	1-1/8"	11	8	140" Long Grain Cart Fixed Tube	EA



Latch Plates - 50 Bundle

PART NO.	FT	IN	UNIT
004-52669-04208	21	11	EA
004-52669-01536	8	-	EA
004-52669-02240	11	8	EA



2" Plastic Roll Tube Cap

PART NO.	UNIT
034-54038	EA



1-1/8" Plastic Fix Tube Cap

PART NO.	UNIT
034-43067	EA



Spline Shaft

PART NO.	UNIT
035-45878	EA



Screw 5/16 - 18 x 1" Self Tapping

PART NO.	UNIT
032-04154	EA



Latch Plate Screw 3/8 - 16 x 1" Self Tapping

PART NO.	UNIT
032-01356	EA



Tube - Steel 2" x 3' x 2" w/ Swedged End

PART NO.	UNIT
099-52597	EA

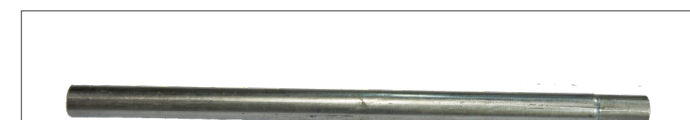

Replacement Tarp Caps

PART NO.	MAKE	STYLE	FRONT/REAR	RISE	TRAILER WIDTH	CAP DEPTH	UNIT
577-54182	Timpte (2009 & Newer)	Vertical	Front	8"	96"	11"	EA
577-54183	Timpte (2009 & Newer)	Vertical	Rear	8"	96"	11"	EA
577-54184	Timpte (2009 & Newer)	Vertical	Front	8"	102"	11"	EA
577-54185	Timpte (2009 & Newer)	Vertical	Rear	8"	102"	11"	EA
577-54186	Timpte (2009 & Newer)	Slanted	Front	8"	96"	11"	EA
577-54187	Timpte (2009 & Newer)	Slanted	Rear	8"	96"	11"	EA
577-54188	Timpte (2009 & Newer)	Slanted	Front	8"	102"	11"	EA
577-54289	Timpte (2009 & Newer)	Slanted	Rear	8"	102"	11"	EA
577-54290	Timpte (2008 & Older)	Vertical	Front	6"	96"	11"	EA
577-54291	Timpte (2008 & Older)	Vertical	Rear	6"	96"	15"	EA
577-54292	Timpte (2008 & Older)	Vertical	Front	6"	102"	11"	EA
577-54293	Timpte (2008 & Older)	Vertical	Rear	6"	102"	15"	EA

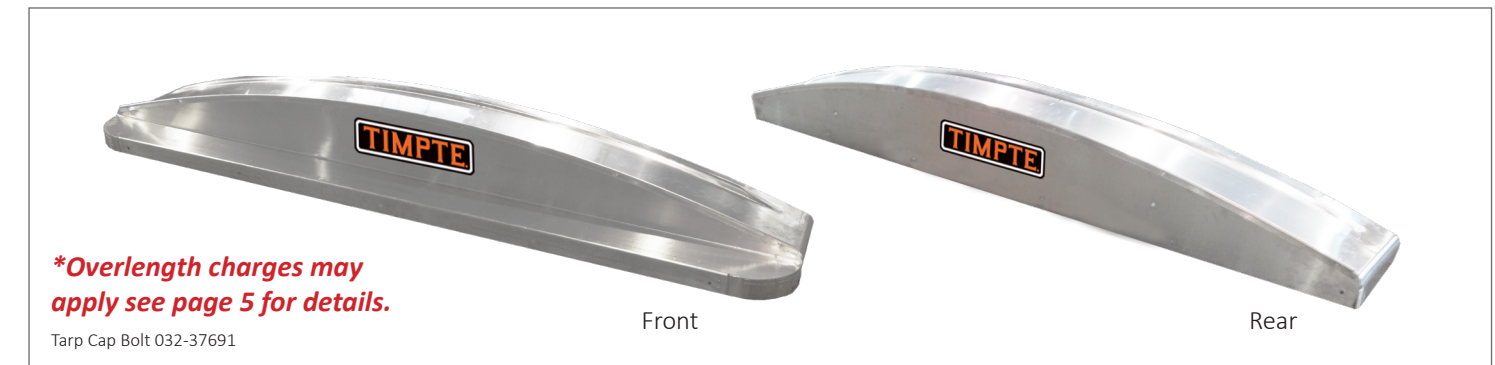

Tarp Cap Seal

PART NO.	DESCRIPTION	UNIT
034-48939	100 ft. Roll	Per Foot



Replacement Tarp Bows

PART NO.	MAKE	TRAILER WIDTH	STYLE	RISE	UNIT
035-25739	Timpte	96"	Reinforced	9"	EA
035-25738	Timpte	96"	Standard	9"	EA
035-27068	Timpte	102"	Reinforced	9"	EA
035-27067	Timpte	102"	Standard	9"	EA
035-56502	Wilson	96"	Reinforced	8"	EA
035-57401	Wilson	102"	Reinforced	8"	EA
101225	Wilson	96"	Reinforced	10"	EA
101226	Wilson	102"	Reinforced	10"	EA
035-44955	Timpte	96"	Standard	12"	EA
035-44956	Timpte	96"	Reinforced	12"	EA
577-61264	Timpte	96"	Aluminum	9"	EA
577-61265	Timpte	102"	Aluminum	9"	EA

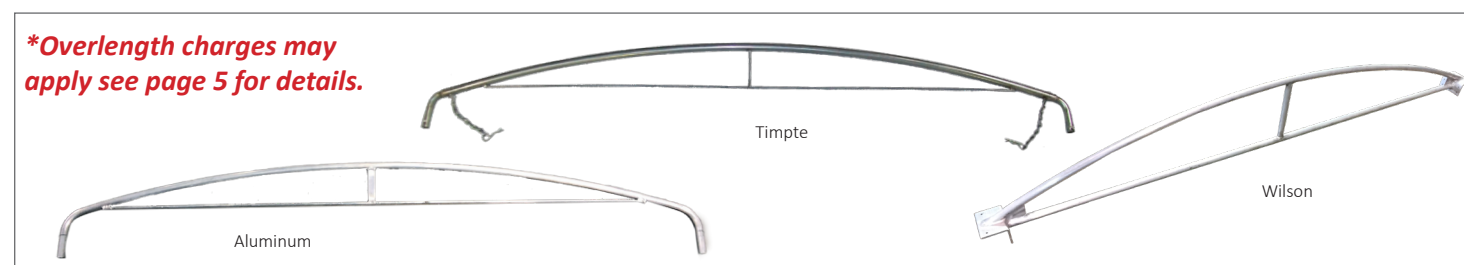

Replacement Tarp Bows - Universal

PART NO.	WIDTH	RISE	DIAMETER	UNIT
491-55165	144"	8" Rise (Tube inserts included)	1"	EA
101065	102"	8" Rise (Low rise)	1"	EA
101064	102"	12" Rise (High rise)	1"	EA

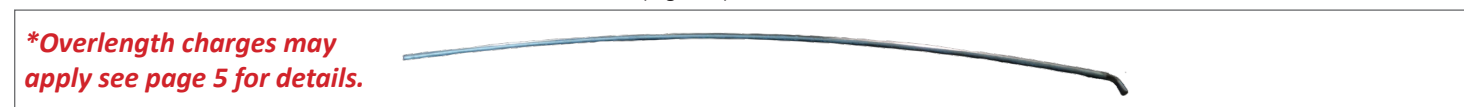

Tarp Bow Bracket 1"

PART NO.	UNIT
046-55163	EA



Flex Bow Composite *Overlength charges may apply see page 5 for details.

PART NO.	UNIT
035-56187	EA



Tarp Bow Tube Insert

PART NO.	DESCRIPTION	UNIT
101069	3/4" O.D. Low Rise	EA
101068	3/4" O.D. High Rise	EA



Flex Bow Socket

PART NO.	DESCRIPTION	UNIT
035-58460	Steel	EA
101510	Aluminum	EA

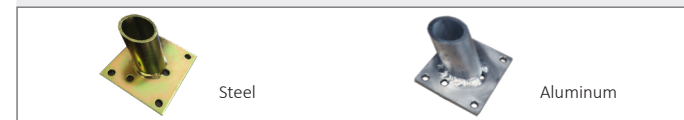

Grain Cart Tarp Kit - Contact Thunderstone for Order Form
Tarp Not Included

*Overlength charges may apply see page 5 for details.

PART NO.	DESCRIPTION	CART WIDTH (UP TO)	CART LENGTH (UP TO)	SUGGESTED TARP WIDTH	UNIT
104059-02304	Kit, Grain Cart Installation 7'-6" Wide Up 12'-4" Long	7'-6"	12'-4"	112-118"	EA
104059-03072	Kit, Grain Cart Installation 7'-6" Wide Up 16' Long	7'-6"	16'	112-118"	EA
104059-04320	Kit, Grain Cart Installation 7'-6" Wide Up 22'-6" Long	7'-6"	22'-6"	112-118"	EA
104060-02304	Kit, Grain Cart Installation 8' Wide Up 12'-4" Long	8'	12'-4"	120-123"	EA
104060-03072	Kit, Grain Cart Installation 8' Wide Up 16' Long	8'	16'	120-123"	EA
104060-04320	Kit, Grain Cart Installation 8' Wide Up 22'-6" Long	8'	22'-6"	120-123"	EA
104061-02304	Kit, Grain Cart Installation 9'-6" Wide Up 12'-4" Long	9'-6"	12'-4"	138"	EA
104061-03072	Kit, Grain Cart Installation 9'-6" Wide Up 16' Long	9'-6"	16'	138"	EA
104061-04320	Kit, Grain Cart Installation 9'-6" Wide Up 22'-6" Long	9'-6"	22'-6"	138"	EA
104062-02304	Kit, Grain Cart Installation 10'-6" Wide Up 12'-4" Long	10'-6"	12'-4"	148"	EA
104062-03072	Kit, Grain Cart Installation 10'-6" Wide Up 16' Long	10'-6"	16'	148"	EA
104062-04320	Kit, Grain Cart Installation 10'-6" Wide Up 22'-6" Long	10'-6"	22'-6"	148"	EA
104063-02304	Kit, Grain Cart Installation 11' Wide Up 12'-4" Long	11'	12'-4"	154"	EA
104063-03072	Kit, Grain Cart Installation 11' Wide Up 16' Long	11'	16'	154"	EA
104063-04320	Kit, Grain Cart Installation 11' Wide Up 22'-6" Long	11'	22'-6"	154"	EA
104064-02304	Kit, Grain Cart Installation 12' Wide Up 12'-4" Long	12'	12'-4"	166"	EA
104064-03072	Kit, Grain Cart Installation 12' Wide Up 16' Long	12'	16'	166"	EA
104064-04320	Kit, Grain Cart Installation 12' Wide Up 22'-6" Long	12'	22'-6"	166"	EA



Grain Cart Tarp Caps *Overlength charges may apply see page 5 for details.

PART NO.	SIZE	UNIT
101400	89" - Cap Only	EA
101408	89" - Cap w/ Installation Fasteners	EA
101631	96" - Cap Only	EA
101143	114" - Cap Only	EA
101149	114" - Cap w/ Installation Fasteners	EA
101170	126" - Cap Only	EA
101178	126" - Cap w/ Installation Fasteners	EA
100841	132" - Cap Only	EA
100840	132" - Cap w/ Installation Fasteners	EA
577-55161	144" - Cap Only	EA
577-55168	144" - Cap w/ Installation Fasteners	EA

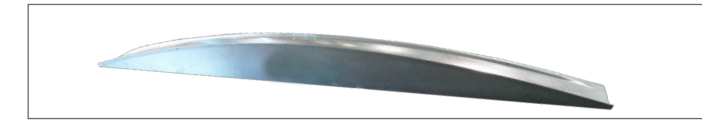

Grain Cart Tarp Bows *Overlength charges may apply see page 5 for details.

PART NO.	SIZE	UNIT
035-55166	144" Tarp Bow Assembly	EA

Grain Cart Thunder Tarp Strap

PART NO.	DESCRIPTION	UNIT
104589	Thunder Tarp Strap (4' Longer) Grain Carts	EA

Grain Cart Tubes & Latch Plate *See page 34 for dimension references

PART NO.	DESCRIPTION	UNIT
035-43064-02240	140" Long Grain Roll Tube	EA
035-43063-02240	140" Long Grain Cart Fixed Tube	EA
004-52669-02240	140" Latch Plate	EA

LEAD TIMES MAY VARY

Grain Cart Replacement Tarps

PART NO.	FEET	INCHES	WIDTH	OUNCE	CART LENGTH	CART WIDTH	MAKE	MODEL
100590	13'	8"	166	18	14'	11'-10"	Demco	550650/750
101660	15'	8"	120	18	16'	8'	-	-
100592	15'	8"	166	18	16'	11'-10"	Parker	739/839
100586	16'	1"	166	18	16'-5"	11'-10"	Brent	780
101138	19'	6"	142	18	20'-2"	10'	-	-
101173	19'	8"	148	18	20'	10'-6"	Killbros	1600
100792	19'	8"	154	22	20'	11'	Kinze	1040
100588	21'	2"	166	18	21'-6"	11'-10"	Brent	8821082
100594	22'	2"	166	18	22'-6"	12'	Kinze	1050
100595	22'	2"	166	22	22'-6"	12'	Kinze	1050

Features

- All-welded tarp technology
- Heat welded seams add strength & thickness to high stress areas
- Made of quality vinyl coated polyester fabric
- Watertight protection
- No stress points from stitching
- Mildew resistant
- Built-in UV inhibitors to reduce cracking & fading
- Puncture resistant (18oz.- 185lbs. & 22oz.- 225lbs.)
- Superior tear strength & abrasion resistant
- 1 year tarp limited warranty



Tarp Fabric Features

- Made of premium-grade woven PVC coated fabric
- Built-in UV inhibitors to reduce cracking and fading
- Rot & mildew resistant
- Superior tear strength and abrasion resistant
- Puncture resistant (18 oz.- 185lbs / 22 oz.- 225lbs)
- -30 degree cold crack protection

Tarp Assembly

- All-welded tarp technology (No Stitch Assembly)
- Heat-welded seams add strength and thickness to high stress areas
- Precision cut by CNC machine

Tarp Color Options

 Black 18 & 22 oz. P/N Suffix -01	 Red 18 & 22 oz. P/N Suffix -02	 Blue 18 & 22 oz. P/N Suffix -03	 Orange 18 oz. P/N Suffix -04	 Burgundy 18 oz. P/N Suffix -05	 Gray 18 & 22 oz. P/N Suffix -06	 White 18 oz. P/N Suffix -07
 Green 18 oz. P/N Suffix -08	 Light Blue 18 & 22 oz. P/N Suffix -09	 Purple 18 oz. P/N Suffix -10	 Yellow 18 oz. P/N Suffix -11	 Brown 18 oz. P/N Suffix -12	 Clean Coat 18 & 22 oz. P/N Suffix -51 Upcharge \$150	

(Colors may not reflect exact tarp color)

See Next Page for Additional Options

Don't see the tarp you're looking for?
Custom Tarps Available Upon Request.





One Piece Tarps



- Improved durability
- No seams to snag
- Improved cosmetics-smoother appearance
- Faster open & close time

Reference Page 41-42

Reinforced Tarps

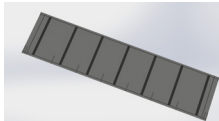

- Extra reinforcing over the tarp bows
- 12" strip of 18 oz. tarp material for added protection
- Used for tough applications where commodity may stick to tarp bows and become abrasive

Reference Page 52

Ridgepole Tarps



- Ridgepoles support the tarp the length of the trailer
- Eliminates ridge straps and reduces the amount of tarp bows used
- Used to reduce the amount of commodity splatter and used for bucket loading and helps keep tarp tight

Reference Page 53

Mesh Tarps

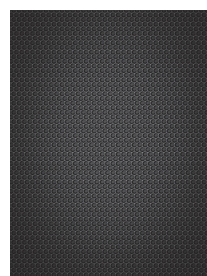

- 10 oz. and 12 oz. Material Available
- Designed for rugged applications
- Used for hauling rock, sand, trash and any load that does not require to be waterproof or windproof

Reference Page 54

Clean Coat Tarp



- Acrylic glaze coating reduces commodity buildup
- Reduces cross-contamination between loads
- Fast & easy to clean compared to standard material

EPA Tarp with Flap

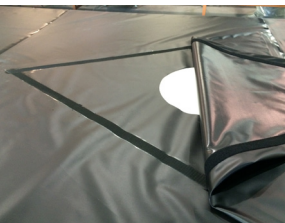

- Heat-Welded design with stitch reinforcement
- Large 18" reinforced round opening for load pipe
- Velcro seal with latch down on EPA tarp opening
- Ability to load in different weather conditions
- Used to meet EPA requirements for dust control

Reference Page 53

EPA Double Tarp



- Most watertight system
- Eliminates operator from having to latch the load hole flap
- Both tarps can be opened for total loading access
- Used to meet EPA requirements for dust control

Reference Page 53

Decontamination Flap



- All Heat-Welded Design
- Extra flap that keeps commodity from sticking to the top rail
- Helps eliminate cross contamination

Reference Page 53

ONE PIECE TARP

PART NO.	FEET	INCHES	TRAILER LENGTH	TRAILER WIDTH	TRAILER MAKE	TRAILER MODEL
103927-01	7'	6"	-	96W	-	-
103771-01	11'	6"	-	96W	-	-
104065-01	15'	2"	-	-	-	-
035-61933	19'	11"	21'	96W	Timpte	-
035-61935	20'	11"	22'	96W	Timpte	-
035-61937	27'	6"	28'	96W	Timpte	-
035-61115	32'	1"	33' 5"	96W	Timpte	-
035-61939	32'	5"	33' 5"	96W	Timpte	-
035-63743	32'	11"	39'	96W	Timpte	Reinforced / Roughneck
035-63746	33'	5"	-	96W	Timpte	Roughneck
035-61941	35'	-	36'	96W	Timpte	-
103100	35'	6"	38'	96W	Jet	-
035-61957	36'	4"	40'	96W	Timpte	-
035-61955	36'	8"	40'	-	Timpte	-
035-61943	36'	11"	38'	96W	Timpte	-
035-63583-01	36'	11"	40'	96W	Timpte	Reinforced / SL
102716	37'	10"	39'	96W	Wilson	-
035-61961	38'	7"	42' 2"	96W	Timpte	SL
035-61945	38'	11"	40'	96W	Timpte	-
102719	39'	4"	-	-	Wilson	-
102714	39'	6"	40'	96W	-	-
102713	39'	10"	41'	96W	Wilson	-
102712	40'	-	41'	96W	Wilson	-
102720	40'	4"	41'	96W	Wilson	-
102717	40'	7"	42'	96W	Wilson	-
035-61112	40'	10"	42' 2"	96W	Timpte	-
035-62099	41'	2"	42' 2"	96W	Timpte	Reinforced
035-61947	41'	2"	42' 2"	96W	Timpte	-
104004-01	41'	4"	-	-	-	-
035-61114	41'	7"	43'	96W	Timpte	-
102715	41'	10"	43'	96W	Wilson	-
035-61949	41'	11"	43'	96W	Timpte	-
103337-01	42'	2"	-	96W	Wilson	-
035-61963	46'	5"	50'	96W	Timpte	SL
035-300019	44'	-	45'	96W	Timpte	-
102718	46'	10"	50'	96W	Timpte	SL
035-61951	47'	-	48'	96W	Timpte	-
035-61953	49'	-	50'	96W	Timpte	-

ONE PIECE TARP

PART NO.	FEET	INCHES	TRAILER LENGTH	TRAILER WIDTH	TRAILER MAKE	TRAILER MODEL
035-61934	18'	2"	21'	96W	Timpte	-
035-61936	20'	11"	22'	96W	Timpte	-
035-61938	27'	6"	28'	96W	Timpte	-
102561-01	29'	6"	39'	96W	Timpte	Reinforced
035-62194	32'	1"	33' 5"	96W	Timpte	-
035-61940	32'	5"	33' 5"	96W	Timpte	-
035-61942	35'	-	36'	96W	Timpte	-
103101	35'	6"	38'	96W	Jet	-
035-61958	36'	4"	40'	96W	Timpte	-
035-61956	36'	8"	40'	-	Timpte	-
035-61944	36'	11"	38'	96W	Timpte	-
102866	37'	10"	39'	96W	Wilson	-
035-61962	38'	7"	42' 2"	96W	Timpte	-
035-61946	38'	11"	40'	96W	Timpte	-
035-63266-01	39'	3"	42' 2"	96W	Timpte	SL
102863	39'	10"	41'	96W	Wilson	-
102862	40'	-	41'	96W	Wilson	-
035-62191	40'	10"	42' 2"	96W	Timpte	-
102871	41'	-	42'	96W	Wilson	-
035-61948	41'	2"	42' 2"	96W	Timpte	-
035-62193	41'	7"	43'	96W	Timpte	-
035-61950	41'	11"	43'	96W	Timpte	-
035-61964	46'	5"	50'	96W	Timpte	SL
102868	46'	10"	50'	96W	Timpte	SL
035-61952	47'	-	48'	96W	Timpte	-
035-61954	49'	-	50'	96W	Timpte	-

STANDARD TARP

PART NO.	FEET	INCHES	TRAILER LENGTH	TRAILER WIDTH	TRAILER MAKE	TRAILER MODEL
101441	15'	4"	-	-	-	-
103692	16'	4"	-	96W	-	-
100467	19'	6"	20'	96W	-	Truck Box
101202	19'	8"	-	-	-	-
100463	19'	10"	22'	96W	Jet	SL
035-46754	19'	11"	21'	96W	Timpte	-
035-36351	20'	7"	22'	96W	Timpte	Pre-2008
035-46756	20'	11"	22'	96W	Timpte	-
101984	21'	3"	-	-	-	-
100434	22'	6"	23'	96W	-	Special Farm Built
101865	23'	4"	-	-	-	-
100643	23'	6"	26'	96W	Jet	-
100717	23'	10"	25'	96W	Dakota	-
101386	25'	5"	26' 4"	96W	-	-
100684	25'	8"	28'	96W	Merritt	-
100952	26'	-	28'	96W	-	-
102022	27'	2"	-	-	-	-
035-46757	27'	6"	28' 6"	96W	Timpte	-
100987	29'	3"	30'	96W	-	-
100847	29'	10"	-	96W	-	-
100948	30'	-	34'	96W	-	-
100526	30'	8"	32'	96W	Timpte	Pre-2004
100649	31'	-	34'	96W	Merritt	SL
100455	31'	4"	34'	96W	Jet	SL / 62" High
100459	31'	6"	34'	96W	Jet	SL / 68" High
100475	31'	8"	34'	96W	Jet	SL / 68" High
101345	31'	10"	-	-	-	-
035-32525	32'	1"	33' 5"	96W	Timpte	Pre-2008
035-46759	32'	5"	33' 5"	96W	Timpte	-
100621	33'	-	34'	96W	Wilson	-
100950	33'	4"	34' 6"	96W	-	-
101562	33'	6"	-	-	-	-
035-53704	33'	9"	35'	96W	Wilson	-
100532	34'	-	36'	96W	Jet	-
101713	34'	4"	-	-	-	-
100574	34'	7"	38' 6"	96W	Dakota	-
035-52435	35'	-	36'	96W	Timpte	-
100653	35'	4"	38'	96W	Merritt	SL
100444	35'	6"	38'	96W	Jet	-

PART NO.	FEET	INCHES	TRAILER LENGTH	TRAILER WIDTH	TRAILER MAKE	TRAILER MODEL
035-56636	35'	10"	36' 10"	96W	Timpte	-
100507	36'	-	37'	96W	Timpte	1978
101341	36'	2"	-	-	-	-
035-48199	36'	4"	40'	96W	Timpte	SL / 72" High
035-48049	36'	8"	40'	-	Timpte	SL / 66" High
035-46761	36'	11"	38'	96W	Timpte	-
100882	37'	2"	38'	96W	Alumatech	-
100858	37'	5"	42'	96W	Neville	-
100550	37'	6"	40'	96W	Jet	-
101354	37'	8"	-	-	-	-
035-53702	37'	10"	39'	96W	Wilson	-
100688	38'	-	39'	96W	Wilson	-
100692	38'	2"	-	-	-	-
100491	38'	4"	42'	96W	Wilson	Commander
035-22358	38'	7"	40'	96W	Timpte	Pre-2008
035-48381	38'	8"	42' 2"	96W	Timpte	SL / 72" High
100798	38'	10"	43'	96W	Merritt	-
035-46762	38'	11"	40'	96W	Timpte	-
035-48174	38'	11"	42' 2"	96W	Timpte	SL / 66" High
100974	39'	2"	41'	96W	Cornhusker	-
101184	39'	4"	-	-	Wilson	-
035-53720	39'	6"	40'	96W	-	-
101220	39'	8"	42'	96W	Jet	-
035-53710	39'	10"	41'	96W	Wilson	-
035-53716	40'	-	41'	96W	Wilson	-
100788	40'	2"	-	96W	Cornhusker	-
035-54191	40'	4"	41'	96W	Wilson	-
100350	40'	7"	42'	96W	Wilson	-
035-22356	40'	10"	42' 2"	96W	Timpte	Pre-2008
100179	41'	-	42'	96W	Wilson	-
035-46764	41'	2"	42' 2"	96W	Timpte	-
101717	41'	5"	46'	96W	Cornhusker	-
035-39336	41'	7"	43'	96W	Timpte	Pre-2008
035-53706	41'	10"	43'	96W	Wilson	-
035-46766	41'	11"	43'	96W	Timpte	-
101748	42'	2"	-	-	-	-
101362	42'	4"	-	-	-	-
100544	42'	6"	44'	96W	Cornhusker	-
100639	42'	10"	44'	96W	Cornhusker	-
100087	43'	-	45'	96W	-	-
100721	43'	3"	44' 4"	96W	Peerless	Walking Floor
035-27394	43'	8"	45'	96W	Timpte	Pre-2008

PART NO.	FEET	INCHES	TRAILER LENGTH	TRAILER WIDTH	TRAILER MAKE	TRAILER MODEL
100342	43'	10"	45'	96W	Wilson	-
035-46768	43'	11"	45'	96W	Timpte	-
102053	44'	2"	-	-	-	-
100909	44'	4"	-	-	-	-
035-27943	44'	8"	46'	96W	Timpte	Pre-2008
102289	45'	-	-	-	-	-
035-30449	45'	2"	46' 6"	96W	Timpte	Pre-2008
035-46770	45'	6"	46' 6"	96W	Timpte	-
035-51810	46'	5"	50'	96W	Timpte	SL / 72" High
100436	46'	8"	48'	96W	Timpte	Pre-2008
035-46772	47'	-	48'	96W	Timpte	-
101833	47'	3"	50'	96W	Wilson	-
100901	47'	6"	50'	96W	Wilson	V-Bottom
101456	47'	8"	-	-	-	-
035-32068	47'	10"	49'	96W	Timpte	Pre-2008
035-47620	48'	-	49'	96W	Timpte	-
035-40719	48'	8"	50'	96W	Timpte	Pre-2008
035-46774	49'	-	50'	96W	Timpte	-
101031	49'	4"	51'	96W	Wilson	V-Bottom
035-47057	50'	-	51'	96W	Timpte	-

PART NO.	FEET	INCHES	TRAILER LENGTH	TRAILER WIDTH	TRAILER MAKE	TRAILER MODEL
101443	15'	4"	-	-	-	-
100735	15'	8"	-	96W	-	Truck Box
100787	18'	6"	-	96W	Cornhusker	-
101204	19'	8"	-	-	-	-
035-46776	19'	11"	21'	96W	Timpte	-
035-40374	20'	7"	22'	96W	Timpte	Pre-2008
100993	21'	7"	23'	96W	-	-
101867	23'	4"	-	-	-	-
100645	23'	6"	26'	96W	Jet	-
100719	23'	10"	25'	96W	Dakota	-
100868	24'	-	26'	96W	-	-
101237	24'	10"	-	-	-	-
101320	25'	-	-	-	-	-
100953	26'	-	28'	96W	-	-
101454	26'	2"	-	-	-	-
101351	26'	11"	27' 10"	-	-	-
035-46779	27'	6"	28' 6"	96W	Timpte	-
100323	27'	9"	29'	96W	Jet	-
101212	28'	6"	30'	96W	Mauer	-
101260	28'	-	-	-	-	-
100949	30'	-	34'	96W	-	-
101398	30'	6"	31' 6"	96W	-	-
100461	31'	6"	34'	96W	Jet	SL / 68" High
100477	31'	8"	34'	96W	Jet	SL / 68" High
035-32526	32'	1"	33' 5"	96W	Timpte	Pre-2008
035-46781	32'	5"	33' 5"	96W	Timpte	-
100447	32'	10"	34'	96W	Wilson	-
100623	33'	-	34'	96W	Wilson	-
100534	34'	-	36'	96W	Jet	-
101715	34'	4"	-	-	-	-
035-52437	35'	-	36'	96W	Timpte	-
100655	35'	4"	38'	96W	Merritt	SL
100484	35'	6"	38'	96W	Jet	SL
103057	35'	8"	-	-	-	-
101766	35'	10"	38'	96W	Neville	-
100509	36'	-	37'	96W	Timpte	1978
101343	36'	2"	-	-	-	-

PART NO.	FEET	INCHES	TRAILER LENGTH	TRAILER WIDTH	TRAILER MAKE	TRAILER MODEL
035-48428	36'	4"	40'	96W	Timpte	SL / 72" High
102933	36'	7"	40'	96W	-	-
035-48427	36'	8"	40'	96W	Timpte	SL / 66" High
035-46783	36'	11"	38'	96W	Timpte	-
100860	37'	5"	42'	96W	Neville	-
100551	37'	6"	40'	96W	Jet	-
101356	37'	8"	-	-	-	-
100690	38'	-	39'	96W	Wilson	-
100694	38'	2"	-	-	-	-
100493	38'	4"	42'	96W	Wilson	Commander
035-22359	38'	7"	40'	96W	Timpte	Pre-2008
035-48426	38'	8"	42' 2"	96W	Timpte	SL / 72" High
100828	38'	10"	43'	96W	Merritt	-
035-46784	38'	11"	40'	96W	Timpte	-
035-48425	38'	11"	42' 2"	96W	Timpte	SL / 66" High
101338	38'	11"	-	-	-	-
100975	39'	2"	41'	96W	Cornhusker	-
101185	39'	4"	-	-	Wilson	-
035-53722	39'	6"	40'	96W	-	-
101267	39'	8"	-	-	-	-
035-53712	39'	10"	41'	96W	Wilson	-
035-53718	40'	-	41'	96W	Wilson	-
100789	40'	2"	-	96W	Cornhusker	-
035-54193	40'	4"	41'	96W	Wilson	-
100352	40'	7"	42'	96W	Wilson	-
035-22357	40'	10"	42' 2"	96W	Timpte	Pre-2008
101059	41'	-	42'	96W	Wilson	-
035-46786	41'	2"	42' 2"	96W	Timpte	-
035-40378	41'	7"	43'	96W	Timpte	Pre-2008
035-53708	41'	10"	43'	96W	Wilson	-
035-46788	41'	11"	43'	96W	Timpte	-
101750	42'	2"	-	-	-	-
100546	42'	6"	44'	96W	Cornhusker	-
035-52160	46'	5"	50'	96W	Timpte	SL / 72" High
035-46794	47'	-	48'	96W	Timpte	-
100903	47'	6"	50'	96W	Wilson	V-Bottom
035-40720	48'	8"	50'	96W	Timpte	Pre-2008
035-46796	49'	-	50'	96W	Timpte	-
101033	49'	4"	51'	96W	Wilson	V-Bottom

PART NO.	FEET	INCHES	TRAILER LENGTH	TRAILER WIDTH	TRAILER MAKE	TRAILER MODEL
035-46755	19'	11"	21'	102W	Timpte	-
035-46582	25'	6"	38'	102W	Timpte	B-Train
101319	25'	3"	-	-	-	-
104134	25'	10"	-	102W	-	-
035-63708	26'	6"	28' 6"	102W	Timpte	B-Train Pup
035-46758	27'	6"	28' 6"	102W	Timpte	-
102575	28'	2"	-	-	-	-
035-48320	29'	-	30'	102W	Timpte	-
100476	31'	8"	34'	102W	Jet	SL / 68" High
101346	31'	10"	-	-	-	-
035-46760	32'	5"	33' 5"	102W	Timpte	-
100533	34'	-	36'	102W	Jet	-
035-52436	35'	-	36'	102W	Timpte	-
100654	35'	4"	38'	102W	Merritt	SL
100483	35'	6"	38'	102W	Jet	SL
035-56637	35'	10"	36' 10"	102W	Timpte	-
100859	37'	5"	42'	102W	Neville	-
101128	37'	6"	40'	102W	Jet	-
100689	38'	-	39'	102W	Wilson	-
035-30460	38'	7"	40'	102W	Timpte	Pre-2008
035-46763	38'	11"	40'	102W	Timpte	-
102200	39'	8"	-	-	-	-
035-53711	39'	10"	41'	102W	Wilson	-
101746	40'	2"	-	-	-	-
035-54192	40'	4"	41'	102W	Wilson	-
100351	40'	7"	42'	102W	Wilson	-
035-28312	40'	10"	42' 2"	102W	Timpte	Pre-2008
100836	41'	-	42'	102W	Wilson	-
035-46765	41'	2"	42' 2"	102W	Timpte	-
101718	41'	5"	46'	96W	Cornhusker	-
035-40379	41'	7"	43'	102W	Timpte	Pre-2008
035-40618	41'	10"	43'	102W	Wilson	-
035-46767	41'	11"	43'	102W	Timpte	-
101749	42'	2"	-	-	-	-
101363	42'	4"	-	-	-	-
100545	42'	6"	44'	102W	Cornhusker	-
100640	42'	10"	44'	102W	Cornhusker	-

PART NO.	FEET	INCHES	TRAILER LENGTH	TRAILER WIDTH	TRAILER MAKE	TRAILER MODEL
100088	43'	-	45'	102W	-	-
100722	43'	3"	44' 4"	102W	Peerless	Walking Floor
101304	43'	5"	-	-	Western	-
035-30462	43'	8"	45'	102W	Timpte	Pre-2008
100343	43'	10"	45'	102W	Wilson	-
035-46769	43'	11"	45'	102W	Timpte	-
103885	44'	2"	-	102W	-	-
100472	44'	10"	46'	102W	Wilson	V-Bottom
035-30464	45'	2"	46' 6"	102W	Timpte	Pre-2008
102322	45'	-	-	-	-	-
100539	46'	-	-	-	-	-
102119	46'	6"	-	-	-	-
100437	46'	8"	48'	102W	Timpte	Pre-2008
100498	46'	10"	50'	102W	Trail King	-
035-46773	47'	-	48'	102W	Timpte	-
035-32191	47'	2"	48' 3"	-	-	-
035-32070	47'	10"	49'	102W	Timpte	Pre-2008
035-47621	48'	-	49'	102W	Timpte	-
035-40721	48'	8"	50'	102W	Timpte	Pre-2009
035-46775	48'	11"	-	-	-	-
101032	49'	4"	51'	102W	Wilson	V-Bottom
035-47059	50'	-	51'	102W	Timpte	-
101841	52'	4"	-	-	-	-

PART NO.	FEET	INCHES	TRAILER LENGTH	TRAILER WIDTH	TRAILER MAKE	TRAILER MODEL
035-46777	19'	11"	21'	102W	Timpte	-
035-52425	25'	6"	38'	102W / 84H	Timpte	B-Train
100652	31'	-	34'	102W	Merritt	-
100462	31'	6"	34'	102W	Jet	SL / 68" High
101348	31'	10"	-	-	-	-
035-46782	32'	5"	33' 5"	102W	Timpte	-
100535	34'	-	36'	102W	Jet	-
100577	34'	7"	38' 6"	102W	Dakota	-
035-52438	35'	-	-	-	-	-
100656	35'	4"	38'	102W	Merritt	SL
035-57825	35'	10"	36' 10"	102W	Timpte	-
102702	36'	7"	-	-	-	-
100885	37'	2"	38'	102W	Alumatech	-
035-30466	38'	7"	40'	102W	Timpte	Pre-2008
035-46785	38'	11"	40'	102W	Timpte	-
102743	39'	2"	-	-	-	-
035-53723	39'	6"	40'	102W	-	-
035-53719	40'	-	41'	102W	Wilson	-
101747	40'	2"	-	-	-	-
100353	40'	7"	42'	102W	Wilson	-
035-28313	40'	10"	42' 2"	102W	Timpte	Pre-2008
101060	41'	-	42'	102W	Wilson	-
035-46787	41'	2"	42' 2"	102W	Timpte	-
035-40380	41'	7"	43'	102W	Timpte	Pre-2008
035-53709	41'	10"	-	-	-	-
035-46789	41'	11"	43'	102W	Timpte	-
101751	42'	2"	-	-	-	-
101365	42'	4"	-	-	-	-
100642	42'	10"	44'	102W	Cornhusker	-
100090	43'	-	45'	102W	-	8" Rise Cap
100724	43'	3"	44' 4"	102W	Peerless	Walking Floor
101306	43'	5"	-	-	Western	-
035-30447	43'	8"	45'	102W	Timpte	Pre-2008
100345	43'	10"	45'	102W	Wilson	-
035-30470	45'	2"	46' 6"	102W	Timpte	Pre-2008
101729	45'	5"	-	-	-	-
100541	46'	-	48'	102W	Eby	Walking Floor
102120	46'	5"	-	-	-	-
035-46795	47'	-	48'	102W	Timpte	-
035-40722	48'	8"	50'	102W	Timpte	Pre-2009
035-46797	49'	-	50'	102W	Timpte	-
035-36059	49'	10"	51'	102W	Timpte	V-Bottom/Pre-2008
035-47060	50'	-	51'	102W	Timpte	-
100636	51'	6"	53'	102W	Vantage	Refuse Hauler
100573	51'	11"	53'	102W	Peerless	Walking Floor
101843	52'	4"	-	-	-	-

PART NO.	FEET	INCHES	WIDTH	OZ.	TRAILER LENGTH	TRAILER WIDTH	TRAILER MAKE	TRAILER MODEL
035-54212	41'	11"	135	18	43'	102W	Timpte	-
035-56660	41'	11"	141		43'	102W	Timpte	-
035-56973	49'	1"	135		50'	102W	Timpte	-
183090	41'	6"	129	-	102W	-	-	9" Rt Pocket
101496	51'	8"	129	22	51' 8"	-	-	9" Rt Pocket
104640	40'	4"	150"	-	-	-	-	-

PART NO.	FEET	INCHES	WIDTH	OZ.	TRAILER LENGTH	TRAILER WIDTH	TRAILER MAKE	TRAILER MODEL	NOTES
035-64163	19'	11"	129			102W			
035-58958	36'	9"	123		40'	96W	Timpte	SL	-
100346	38'	11"	123		40'	96W	Timpte	-	-
035-50814	38'	11"	123		40'	96W	Timpte	Super Tender	Full Height Divider
100347	38'	11"	129		40'	102W	Timpte	-	-
035-63581	39'	3"	123		42' 2"	96W	Timpte	SL	
100403	41'	2"	123		-	-	-	-	Reinforced Bows
102557	41'	10"	123			96W			
035-61340	41'	11"	123		43'	96W	Timpte		
035-54516	41'	11"	129		43'	102W			
035-54544	42'	2"	123		42' 2"	96W	-	-	Reinforced Bows/Caps
035-57456	46'	6"	123		50'	96W	Timpte	SL / 72" High	Reinforced Bows
035-63907	46'	10"	123		50'	96W	Timpte	SLT	
035-54771	47'	-	123		48'	96W	Timpte		
035-59736	47'	-	129		48'	102W	-	-	Reinforced Bows/Caps
035-56347	49'	-	123		50'	96W	Timpte	-	-
100771	49'	-	123		50'	96W	Wilson		
035-55537	48'	11"	129		50'	102W	Timpte	-	-
100348	38'	11"	123		40'	96W	Timpte	-	-
100349	38'	11"	129		40'	102W	Timpte	-	-
035-59540	41'	11"	129		43'	102W	-	-	Reinforced Bows
035-59803	41'	2"	123		42' 2"	96W	Timpte	-	Reinforced Bows/Caps/Plate
035-59554	41'	2"	132		41' 2"	96W	Timpte	-	Reinforced Bows 9" Extra W
035-57294	41'	3"	129		42' 2"	102W	Timpte	-	-
035-62616	41'	11"	123"		43'	96W	Timpte		
101809	43'	11"	129		45'	102W	Timpte		
035-61151	47'	-	123		47'	-	-	-	Reinforced Bows/Caps
035-57455	48'	11"	129		50'	102W	Timpte	-	-
035-57454	49'	-	123		50'	96W	-	-	-

EPA - Tarp with Flap

PART NO.	FEET	INCHES	WIDTH	OZ.	TRAILER LENGTH	TRAILER WIDTH	TRAILER MAKE	TRAILER MODEL	NOTES
035-46805	38'	11"	123		40'	96W	Timpte	-	2 Hole
035-46809	41'	2"	123		42' 2"	96W	Timpte	-	2 Hole
035-55638	46'	11"	123		48'	96W	Timpte	-	2 Hole
035-46810	41'	2"	123	22	42' 2"	96W	Timpte	-	2 Hole
035-46814	41'	11"	123		43'	96W	Timpte	-	2 Hole
104500	41'	11"	123		43'	96W	Timpte		
035-47027	49'	1"	129		50'	102W			3 Holes

EPA - Double Roll Tarps

PART NO.	BOTTOM TARP	TOP TARP	OZ.	TARP LENGTH	FIRST HOLE FROM FRONT OF TARP	SECOND HOLE FROM FRONT OF TARP	HOLE DIAMETER
035-59690	111"	123"	18	41'-2"	11'-9"	29'-2"	18"
035-59289	111"	123"	22	41'-11"	11'-3"	30'-5"	18"

Ridge Pole Tarps

PART NO.	FEET	INCHES	WIDTH	OZ.	TRAILER LENGTH	TRAILER WIDTH	TRAILER MAKE	TRAILER MODEL	NOTES
101876	38'	11"	123	18	40'	96W			
103287	48'	10"	135	18	50'		Trinity		
104096	48'	9"	123	18		96W			
104056	39'	6"	123	22		96W			
103766	18'	-	129	22		102W			
153062	39'	8"	129	22		102W			

Specialty Tarps

PART NO.	FEET	INCHES	WIDTH	OZ.	TRAILER LENGTH	TRAILER WIDTH	TRAILER MAKE	TRAILER MODEL	NOTES
101876	38'	11"	129	22		102W	Wilson		Decontamination
104092	41'	2"	111	18	42' 2"	96W	Timpte		Double EPA - 2 Hole
102421	41'	9"	129	22		102W			End Flap
103449	20'	-	84	22					Mesh
104110	37'	-	111.5	18				Vantage	Tapered
104108	36'	4"	129	18				Vantage	Tapered

Mesh Tarps 10 & 12 oz., Black Only

PART NO.	FEET	INCHES	WIDTH	OZ.	TRAILER LENGTH	TRAILER WIDTH	TRAILER MAKE	TRAILER MODEL	NOTES
153055	28'	-	129	10		102W	Mas		Reinforced
101615	30'	-	129	10	31'	102W	Mas	-	1 Solid Panel
102554	30'	-	129	10		102W	Mas		Reinforced
102274	31'	-	129	10		102W	Mas		Reinforced
103915	31'	-	129	10		102W	Mas		Reinforced
101646	31'	-	129	10	38'	102W	Mas	End Dump	-
102844	32'	-	129	10	-	-	Mas	-	Reinforced
102701	34'	-	129	10		102W			
102288	35'	-	129	10		102W			
101137	35'	-	129	10	36'	102W	Mas	End Dump	-
101814	35'	-	129	10	-	-	-	-	Reinforced 2 Places
101493	37'	-	129	10	38'	102W	Mas	-	-
104107	39'	10"	129	10		102W	Mas		Reinforced
103201	29'	-	129	12		102W	Mas		Reinforced
152710	33'	-	129	12		102W	Mas		Reinforced
183037	36'	-	129	12		102W	Mas		Reinforced
102723	37'	-	129	12		102W	Mas		Reinforced
102724	37'	-	129	12		102W			Reinforced
102624	38'	-	129	12		102W	Mas		Reinforced
102708	28'	-	129	12		102W	Mas		Reinforced
102838	39'	-	129	12	-	-	Mas	-	Reinforced
153362	42'	5"	129	12		102W			
103186	46'	-	129	12		102W			
104608	46'	5"	129	12		102W			
103343	46'	6"	129	12		102W			
103501	47'	-	129	12		102W			
103231	47'	6"	129	12		102W			
101547	35'	10"	144	12					
103828	33'	7"	144	12				Side Dump	
153343	39'	10"	150	12				Side Dump	
183303	35'	10"	150	12				Side Dump	
183317	29'	10"	150	12				Side Dump	
183318	31'	10"	150	12				Side Dump	

*Mesh Tarps come in Black (-01) only for 10 oz. & 12 oz.

Tarp Adhesive

PART NO.	UNIT
100973	8 oz.
035-52002	32 oz.
100830	128 oz.



*Cases Available:
12 - 8 oz.
12 - 32 oz.
6 - 128 oz.

**Next Day Air Not Available

Tarp Repair Kit for 18 & 22oz.

PART NO.	UNIT
035-39446	EA



*Includes 10sqft. of material

Available in:
Black, Red, Blue,
Gray, White,
Yellow

**Next Day Air Not Available

Tarp Solvent

PART NO.	UNIT
035-51993	EA



**Next Day Air Not Available

Repair Strip with Adhesive Backing

PART NO.	LENGTH	WIDTH	UNIT
101134	12"	6"	PER FT.
101297	50'	6"	EA

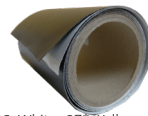

Available in:
Black- 01, Red- 02, Blue- 03, Gray- 06, White- 07*, Yellow- 11*

*Price may vary

General Return Policy

All products sold and shipped* from Thunderstone Manufacturing may be returned within 30 days of receiving it. All product(s) returned must be in original packaging, including all items originally packaged with the product (documentation, user's manual, accessories, etc). All products are subject to a 20% re-stocking fee. After 30 days all purchases are final.

*General return policy excludes all custom tarps or product(s).

ITEMS THAT ARE DEFECTIVE, DAMAGED IN SHIPPING, OR INCORRECT

If your item(s) is defective, is not the item you ordered, or was damaged in shipping you may return your item(s) to Thunderstone Manufacturing. You will be entitled to a full refund or replacement, which will then be credited back to your original method of payment only. If the return is a result of our error, defective materials, or damaged during shipping, you will not be charged for return shipping.

SHIPPING

All orders are shipped F.O.B. from Thunderstone Manufacturing, LLC, Lincoln, NE. All shipments are made by most reasonable means in accordance with size and weight of order.

WARRANTY CLAIM & POLICY

Thunderstone Manufacturing warrants each product to be free from defects in material and workmanship for a period of times set forth in the warranty table listed below. During this period of time, if a customer is unable to resolve a product problem and Thunderstone Customer Service determines the product to be defective, a Return Goods Authorization (RGA) will be issued. Follow receipt of an RGA number, the customer may be asked to return the product to Thunderstone Manufacturing, freight prepaid. This warranty is voided if the customer uses the product in an unauthorized or improper way, or in an environment for which it was not designed. This warranty is applicable to the first purchaser only.

Thunderstone Warranty Categories

PRODUCT DESCRIPTION	WARRANTY COVERAGE
Thunder Power Tarp 7000 Series Kit	4 Year Motor / 3 Year Component Parts
EZ Flow Hydraulic Trap Kit	3 Year Component Parts / 1 Year Hoses & Cylinders
Thunderstone Tarps	1 Year Parts Only
Thunderstone Mesh Tarps	90 Days Parts Only
All Remaining Catalog Items	90 Days Parts Only
Thunder 7000 Upgrade Kit	1 Year Parts Only/ 2 Year Keypad Only
2023 & Older Tarp Keypads	90 Days Parts Only
2024 & Newer Tarp Keypads	2 Years Parts Only

Please have the following items ready prior to submitting a warranty claim - original receipt, serial number(s) (If applicable), and photos of defective product.

To file a claim or if have any questions concerning warranty, contact the Thunderstone Manufacturing Customer Service Department.

Thunderstone Manufacturing, LLC
 4545 West Cuming Street
 Lincoln, NE 68524
 (P) 402.435.4249
 warranty@thunderstonemfg.com

Thunderstone Manufacturing, LLC Discretion

Thunderstone Manufacturing, LLC reserves the right to deny any returned item(s)
 Note: All Prices in this catalog are subject to change without notice.
 * 99% Fill Rate within 48 Hours excludes items on back order & special item orders



EZ Flow Keypad & Control Box

PART NO.	DESCRIPTION	UNIT
035-62893	EZ Flow Control Box	EA
577-61119	EZ Flow Keypad w/ Bracket	EA



Hydraulic Power Units

PART NO.	DESCRIPTION	UNIT
102214	Pump 12VDC Hyd. 1 Gallon Res	EA

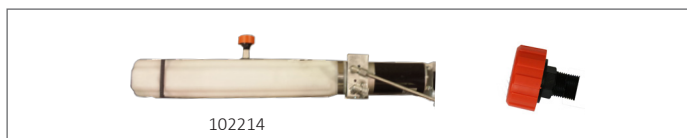

Valves

PART NO.	DESCRIPTION	UNIT
103373	100 PSI Pilot Check Valve	EA
103239	Blocking Valve Cartridge	EA



EZ Flow Keypad Bracket

PART NO.	MAKE	UNIT
103882	Roughneck	EA



Quick Release Yoke

PART NO.	SIZE	UNIT
035-59743	5/8 - 11 (Std Door)	EA



Quick Release Pin

PART NO.	UNIT
035-59745	EA



Blocking Valves

PART NO.	DESCRIPTION	UNIT
029-49864	Double Blocking Valve	EA
029-54347	Single Blocking Valve	EA

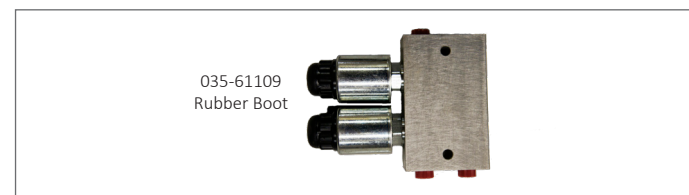

Cross Shafts

PART NO.	DESCRIPTION	UNIT
365-58981	Shaft Cross for 96" w	EA



Door Bracket - Quick Release

PART NO.	DESCRIPTION	UNIT
577-59749	CBSD Front/RDSD Rear	EA
577-59750	RDSD Front/CBSD Rear	EA



EZ Flow Hydraulic Fluid

Only Hydraulic oil recommended for EZ Flow

PART NO.	UNIT
577-55236	2 Gallon
101153	1 Gallon



Preventative Maintenance Kit

PART NO.	UNIT
101316	EA

Kit includes: Breather fill cap (1), Breather bushing (1), Fill hole grommet (1), Oil pickup screen assembly (1), Reservoir O-Ring (1), 1 Gallon Hydraulic Oil



Override System Replacement Strap

PART NO.	UNIT
035-60814-00576	EA



Override System Box Unit

PART NO.	UNIT
034-61002	EA



Hydraulic Cylinders

PART NO.	SIZE/DESCRIPTION	UNIT
029-57701	36" - '17 Timple	EA
029-50514	31" - Timple	EA

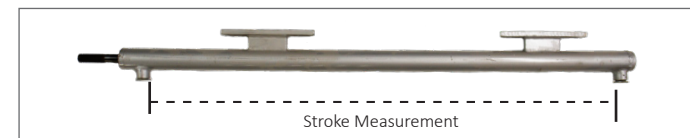

Hydraulic Adaptors

PART NO.	SIZE/DESCRIPTION	UNIT
029-49657	3/8" Elbow 90° 3/8" JIC-O-Ring	EA
029-50223	3/8" Tee 3/8" JIC-FJIC	EA
029-50225	3/8" Straight 3/8" JIC-O-Ring	EA
029-50435	3/8" Adaptor 90° 3/8" JIC-FJIC	EA
029-49655	3/8" Adapter Bulkhead, 90° JIC-FJIC	EA



Hydraulic Power Unit Mounting Bracket

PART NO.	DESCRIPTION	UNIT
100970	Bracket - 1 Gal Res	EA
103604	U-Bolt	EA



Hydraulic Hoses

PART NO.	SIZE/DESCRIPTION	UNIT
029-51241	3/8"x152" Long - 3/8" FJIC x 3/8" 90° FJIC	EA
029-53989	3/8"x46-1/2" Long - 3/8" FJIC x 3/8" FJIC	EA
029-51242	3/8"x176" Long - 3/8" FJIC x 3/8" 90° FJIC	EA
029-53992	3/8"x52-1/2" Long - 3/8" FJIC x 3/8" FJIC	EA



Power Cord Kits/Cable

PART NO.	GA	LENGTH	AMP	DESCRIPTION	RECOMMENDED USE	UNIT
577-61116	4	25'	100	25' Power Cord Kit / 2 Pole Plug/ With Lugs	EZ Flow Hydraulic Trap	EA



Circuit Breakers

PART NO.	DESCRIPTION	UNIT
031-51335	100 Amp Automatic Reset	EA



Cable Dual Conductors

PART NO.	GA	LENGTH	DESCRIPTION	UNIT
031-51092	4	Bulk Min. Order 20'	Cable Dual Conductor	FT.
031-49371	6	Bulk Min. Order 20'	Cable Dual Conductor	FT.



Plug - 2 Pole

PART NO.	DESCRIPTION	UNIT
031-51222	Vertical Pin	EA



Boot Rubber - 2 Pole Vertical 6GA

PART NO.	UNIT
034-51020	EA



Receptacle - 2 Pole Vertical 6GA

PART NO.	DESCRIPTION	UNIT
031-51223	Vertical	EA



Aluminum Spacer & Retainer Ring

PART NO.	UNIT
100670	EA
032-53731	EA

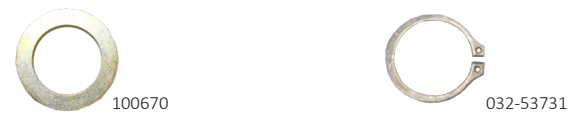

Spring Spiral Torsion 1.25"

PART NO.	UNIT
035-52592	EA



Stabilizing Bushing

PART NO.	UNIT
100661	EA



Motor Adaptor Assembly

PART NO.	DESCRIPTION	UNIT
101448	21" Tube	EA
101776	42" Tube	EA



Arm Replacement Assemblies

PART NO.	SIZE/DESCRIPTION	UNIT
104022-01	Front Arm Install w/ Electronics - Mill	EA
104023-01	Rear Arm Install w/ Mounting Bracket - Mill	EA

Does Not Include Mounting Bracket

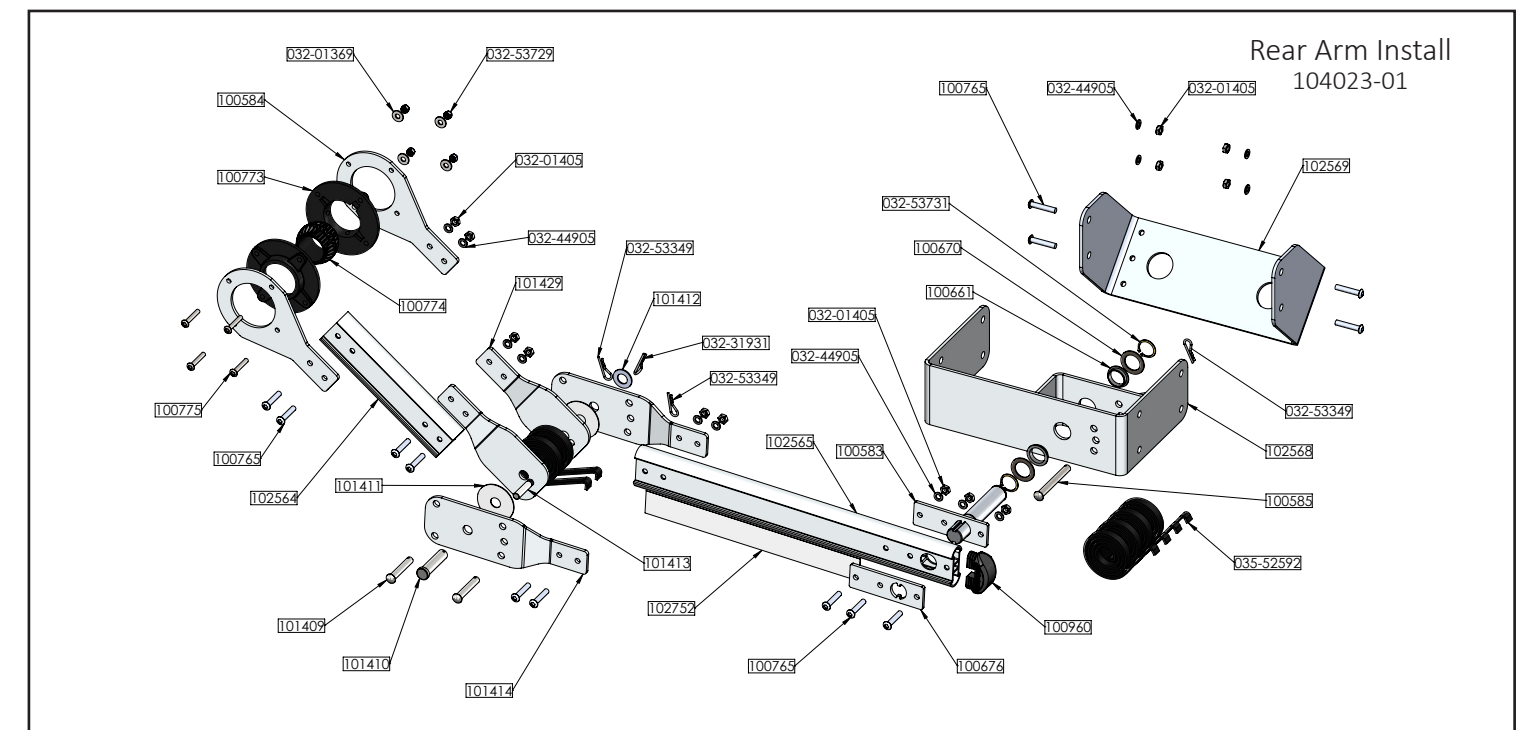
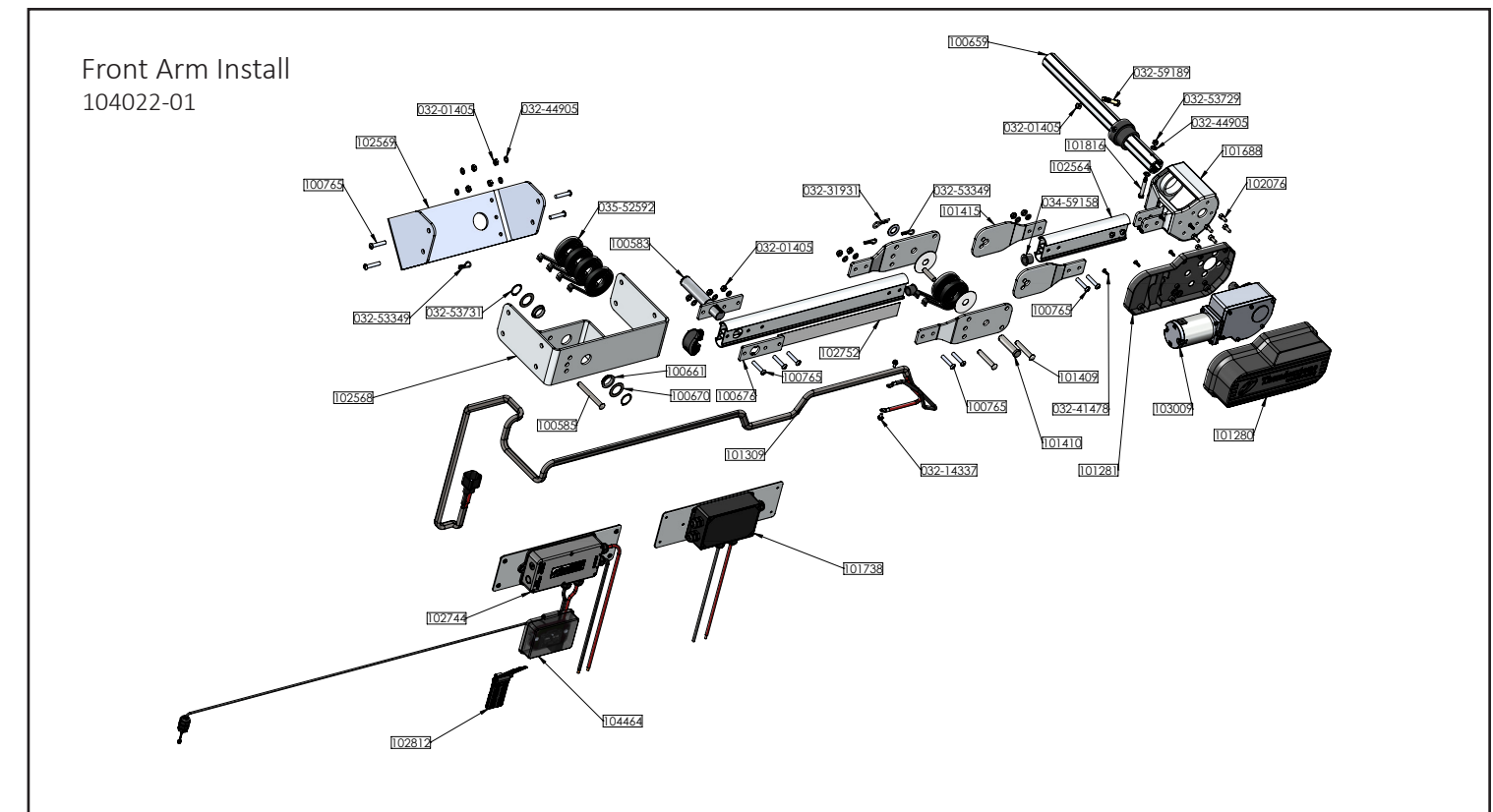

Spherical Bushing Mount Bracket

PART NO.	UNIT
100584-01	EA



Rear Arm Bushing Assembly

PART NO.	UNIT
101418-01	EA

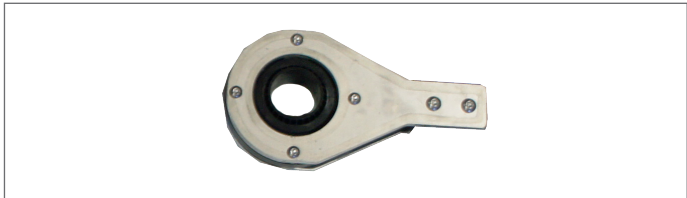

Plastic Spherical Bushing Housing & Ball

PART NO.	DESCRIPTION	UNIT
100773	Housing	EA
100774	Ball	EA



Locking Collar 2" ID x 1" Long

PART NO.	UNIT
034-53699	EA



Multi-Function Remotes

PART NO.	DESCRIPTION	UNIT
102812	Roughneck Remote	EA
035-52097	Replacement Battery	EA



Keypad

PART NO.	DESCRIPTION	UNIT
102121	Keypad - Includes Cover Box	EA
577-301273	Keypad Cover Box Only	EA



Rubber Keypad Grommet

PART NO.	UNIT
034-53341	EA



Control Box - Thunderstone Motor Only

PART NO.	UNIT
102779	EA



Harness Wiring - Motor to Harness

PART NO.	DESCRIPTION	UNIT
101309	Motor to Harness	EA
101619	Relay to Harness	EA

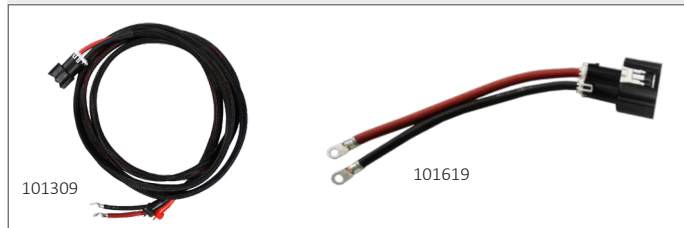

Thunder 7000 Decal

PART NO.	DESCRIPTION	UNIT
102752	Standard	EA



Plastic Bushing Motor End

PART NO.	UNIT
100772	EA



Tube - Steel 2" x 3' x 2" w/ Swedged End

PART NO.	UNIT
099-52597	EA



Upper Arm Extrusion 12" Long

PART NO.	UNIT
102564-01	EA



Lower Arm Assembly 26" Long

PART NO.	UNIT
102565-01	EA



Motor Head Assembly

PART NO.	UNIT
104100-01	EA



Front Spring Knuckle Assembly

PART NO.	UNIT
101416-01	EA



Rear Spring Knuckle Assembly

PART NO.	UNIT
101417-01	EA



Arm Mounting Bracket - Only

PART NO.	DESCRIPTION	UNIT
102568-01	Mill Bracket	EA



Bracket Reinforcement

PART NO.	UNIT
041-63199	EA



Outer Plate Lower Arm Pivot

PART NO.	UNIT
100676-01	EA

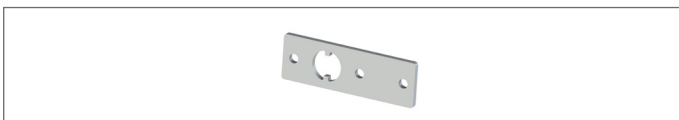

Assembly Outer Arm Mount

PART NO.	DESCRIPTION	UNIT
104572-01	Front Assembly	EA
104573-01	Rear Assembly	EA

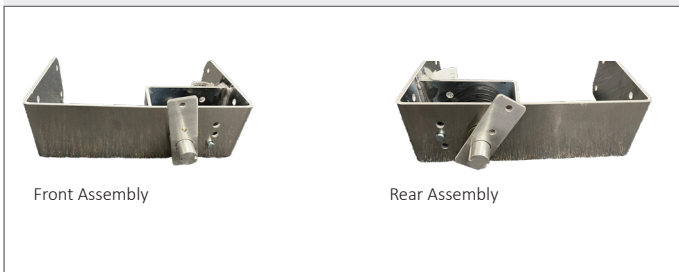

Front/Rear Mounting Bracket

PART NO.	DESCRIPTION	UNIT
102569-01	Mounting Bracket	EA



Plug Arm End

PART NO.	UNIT
100960	EA



Pin Clevis

PART NO.	SIZE	UNIT
100585	1/2" x 4.5"	EA



General Return Policy

All products sold and shipped* from Thunderstone Manufacturing may be returned within 30 days of receiving it. All product(s) returned must be in original packaging, including all items originally packaged with the product (documentation, user's manual, accessories, etc). All products are subject to a 20% re-stocking fee. After 30 days all purchases are final.

*General return policy excludes all custom tarps or product(s).

ITEMS THAT ARE DEFECTIVE, DAMAGED IN SHIPPING, OR INCORRECT

If your item(s) is defective, is not the item you ordered, or was damaged in shipping you may return your item(s) to Thunderstone Manufacturing. You will be entitled to a full refund or replacement, which will then be credited back to your original method of payment only. If the return is a result of our error, defective materials, or damaged during shipping, you will not be charged for return shipping.

SHIPPING

All orders are shipped F.O.B. from Thunderstone Manufacturing, LLC, Lincoln, NE. All shipments are made by most reasonable means in accordance with size and weight of order.

WARRANTY CLAIM & POLICY

Thunderstone Manufacturing warrants each product to be free from defects in material and workmanship for a period of times set forth in the warranty table listed below. During this period of time, if a customer is unable to resolve a product problem and Thunderstone Customer Service determines the product to be defective, a Return Goods Authorization (RGA) will be issued. Follow receipt of an RGA number, the customer may be asked to return the product to Thunderstone Manufacturing, freight prepaid. This warranty is voided if the customer uses the product in an unauthorized or improper way, or in an environment for which it was not designed. This warranty is applicable to the first purchaser only.

Thunderstone Roughneck Warranty Categories

PRODUCT DESCRIPTION	WARRANTY COVERAGE
Thunder Power Tarp 7000 Series Kit	1 Year Motor / 1 Year Component Parts
EZ Flow Hydraulic Trap Kit	1 Year Component Parts / 1 Year Hoses & Cylinders
Thunderstone Tarps	1 Year Parts Only
All Remaining Catalog Items	90 Days Parts Only

Please have the following items ready prior to submitting a warranty claim - original receipt, serial number(s) (if applicable), and photos of defective product.

To file a claim or if have any questions concerning warranty, contact the Thunderstone Manufacturing Customer Service Department.

Thunderstone Manufacturing, LLC
 4545 West Cuming Street
 Lincoln, NE 68524
 (P) 402.435.4249
 warranty@thunderstonemfg.com

Thunderstone Manufacturing, LLC Discretion

Thunderstone Manufacturing, LLC reserves the right to deny any returned item(s)

Note: All Prices in this catalog are subject to change without notice.

* 99% Fill Rate within 48 Hours excludes items on back order & special item orders



EZ Cover by Lincoln Marine, a division of Thunderstone Manufacturing LLC, is the newest innovation in boat protection from nature's elements. Not only is it effortless, it's time efficient! Simply press a button on your wireless remote to roll your custom cover onto your boat, covering the sides and back of the boat. No need to hassle with straps or snaps. Boating just got that much better, spend more time on the water and less time on the docks!



Motor & Drive Warranty
First Year from Date of
Purchase









Track System Warranty
First 5 Years from Date
of Purchase



Tarp Material Warranty
First 5 Years from Date
of Purchase. Exclusions
may apply.

Features & Benefits

-  Best value in the area with quick response on lead times and product delivery.
-  90% automatic tarp cover, less time spent getting your boat covered and more time on the water.
-  Custom fit tarp to ensure boat stays clean and free of any outside debris.
-  Tarp material is mold & mildew resistant providing longer lasting tarp coverage.
-  Easy installation with unobstructed views to the water.
-  Covered with great warranty that will make it easy to keep your boat in great condition.

